

# **2016 Engineering Assessments of Coal Combustion Residual (CCR) Facilities, Intermountain Power Plant**

*Prepared for*

Intermountain Power Service Corporation (IPSC)

October 17, 2016

GCI project number: 15GCI634

October 17, 2016

Prepared for:  
Mr. Blaine Ipson, PE  
Intermountain Power Service Corporation  
850 West Brush Wellman Road  
Delta, UT 84624

Cc: Kevin Murray and Ben Machlis [Holland & Hart]

**2016 Engineering Assessments of Coal Combustion Residual (CCR) Facilities,  
Intermountain Power Plant**



Travis M. Gerber, PhD, PE  
Principal Engineer

A handwritten signature in blue ink that reads "Phil C. Gerhart".

Phil C. Gerhart, PE  
Principal Engineer

A handwritten signature in blue ink that reads "Scott W. Davis".

Scott W. Davis, PE  
Senior Engineer

# TABLE OF CONTENTS

---

|   |            |
|---|------------|
| <b>SECTION 1 Introduction and Background.....</b>                                 | <b>1-1</b> |
| 1.1 GENERAL.....  | 1-1        |
| 1.2 PURPOSE, AUTHORIZATION, AND SCOPE OF WORK.....                                | 1-2        |
| 1.3 REFERENCES TO CFR.....  | 1-2        |
| <b>SECTION 2 Assessments of Bottom Ash Basin .....</b>                            | <b>2-1</b> |
| 2.1 BOTTOM ASH BASIN – LINER DESIGN [257.71].....                                 | 2-1        |
| 2.2 BOTTOM ASH BASIN – STRUCTURAL INTEGRITY<br>[257.73].....                      | 2-1        |
| 2.2.1 General [Portions of 257.73(a) through (c)].....                            | 2-1        |
| 2.2.1.1 Hazard Classification.....  | 2-1        |
| 2.2.1.2 Additional Descriptions of Unit.....                                      | 2-2        |
| 2.2.2 Structural Stability Assessments [257.73(d)].....                           | 2-4        |
| 2.2.3 “Safety Factor” Assessments [257.73(e)].....                                | 2-5        |
| 2.3 BOTTOM ASH BASIN – HYDROLOGIC AND HYDRAULIC<br>CAPACITY [257.82].....         | 2-7        |
| <b>SECTION 3 Assessments of Waste Water Basin .....</b>                           | <b>3-1</b> |
| 3.1 WASTE WATER BASIN – LINER DESIGN [257.71].....                                | 3-1        |
| 3.2 WASTE WATER BASIN – STRUCTURAL INTEGRITY<br>[257.73].....                     | 3-1        |
| 3.2.1 General [Portions of 257.73(a) through (c)].....                            | 3-1        |
| 3.2.1.1 Hazard Classification.....  | 3-1        |
| 3.2.1.2 Additional Descriptions of Unit.....                                      | 3-2        |
| 3.2.2 Structural Stability Assessments [257.73(d)].....                           | 3-4        |
| 3.2.3 “Safety Factor” Assessments [257.73(e)].....                                | 3-5        |
| 3.3 WASTE WATER BASIN – HYDROLOGIC AND<br>HYDRAULIC CAPACITY [257.82].....        | 3-6        |
| <b>SECTION 4 Combustion By-Product Landfill.....</b>                              | <b>4-9</b> |
| 4.1 COMBUSTION BY-PRODUCT LANDFILL – RUN-ON AND<br>RUN-OFF CONTROLS [257.81]..... | 4-9        |
| 4.1.1 GENERAL.....  | 4-9        |
| 4.1.2 RUN-ON CONTROL.....   | 4-10       |
| 4.1.3 RUN-OFF CONTROL.....  | 4-10       |
| <b>SECTION 5 Conclusion .....</b>   | <b>5-1</b> |
| 5.1 LIMITATIONS.....  | 5-1        |

# TABLE OF CONTENTS

---

## List of Tables

- Table 2-1 Summary of Slope Stability Analysis Results – Bottom Ash Basin  
Table 3-1 Summary of Slope Stability Analysis Results – Waste Water Basin

## List of Figures

- Figure 1-1 Vicinity Map  
Figure 1-2 Site Map

## List of Appendices

- Appendix A Available Drawings and Specifications  
Appendix B Results for Slope Stability Assessments  
Appendix C Area-Capacity Curve Information  
Appendix D Run-on / Run-off Supporting Information

**1.1 GENERAL**

This document presents engineering assessments of coal combustion residual (CCR) facilities at the Intermountain Power Plant (IPP), near Delta, Utah (see Figure 1-1). These assessments are generally made pursuant to the following sections/paragraphs of Code of Federal Regulations (CFR) Title 40 “Protection of Environment”, Part 257 “Criteria for Classification of Solid Waste Disposal Facilities and Practices,” Subpart D “Standards for the Disposal of Coal Combustion Residuals in Landfills and Surface Impoundments”:

- 257.71: Liner Design Criteria for Existing CCR Surface Impoundments
- 257.73(c) through 257.73(e): Structural Integrity Criteria for Existing CCR Surface Impoundments
- 257.81: Run-on and Run-off Controls for CCR Landfills
- 257.82: Hydrologic and Hydraulic Capacity Requirements for CCR Surface Impoundments

The Intermountain Power Plant is owned by Intermountain Power Agency (IPA) and operated by Intermountain Power Service Corporation (IPSC). Existing CCR surface impoundments at the facility include the Bottom Ash Basin and the Waste Water Basin. Existing facilities also include a CCR landfill, referred to as the Combustion By-Products Landfill. These CCR units are shown in Figure 1-2.

The Bottom Ash Basin was commissioned in 1986. The Bottom Ash Basin receives bottom ash sluiced from the boilers and the boiler area sump. The Basin also provides decant water to the ash water recycle basin for reuse in the ash water system and the sulfur dioxide removal system. The major sources of materials placed in the basin are the bottom ash, boiler slag, and other process materials including pulverized rejects, and chemical clean residue.

The Waste Water Basin was commissioned in 1986. The major sources of materials placed in the basin include flue gas emission control residuals and other process material including process water separated for re-use, wash down, coal pile run-off, boiler blowdown, cooling tower blowdown, regenerant, rinsate, leachate from bottom ash, boiler slag, and pulverizer rejects. After solids have settled, the water is reused.

The Combustion By-Products Landfill was commissioned in 1986. The major sources of materials placed in the landfill include dewatered blowdown from the scrubbers mixed with fly ash from the baghouse, and settled-out solids from both the Bottom Ash Basin and Waste Water Basin.

In the context of Title 40, Part 257 requirements, the Intermountain Power Plant (IPP) does not discharge water to any waterway and is not located on any waterway.

### **1.2 PURPOSE, AUTHORIZATION, AND SCOPE OF WORK**

This report presents the results of engineering assessments performed by Gerhart Cole Inc. (GCI) for IPSC in response to new federal requirements pertaining to the disposal of coal combustion residuals (CCR), pursuant to CFR Title 40, Part 257.

Subjects of the assessments are the Bottom Ash Basin, the Waste Water Basin, and the Combustion By-Products Landfill.

### **1.3 REFERENCES TO CFR**

To facilitate its use, this document references specific sections, paragraphs and clauses of CFR Title 40, Part 257, using the Title's nomenclature such as 257.73(c)(1)(i).

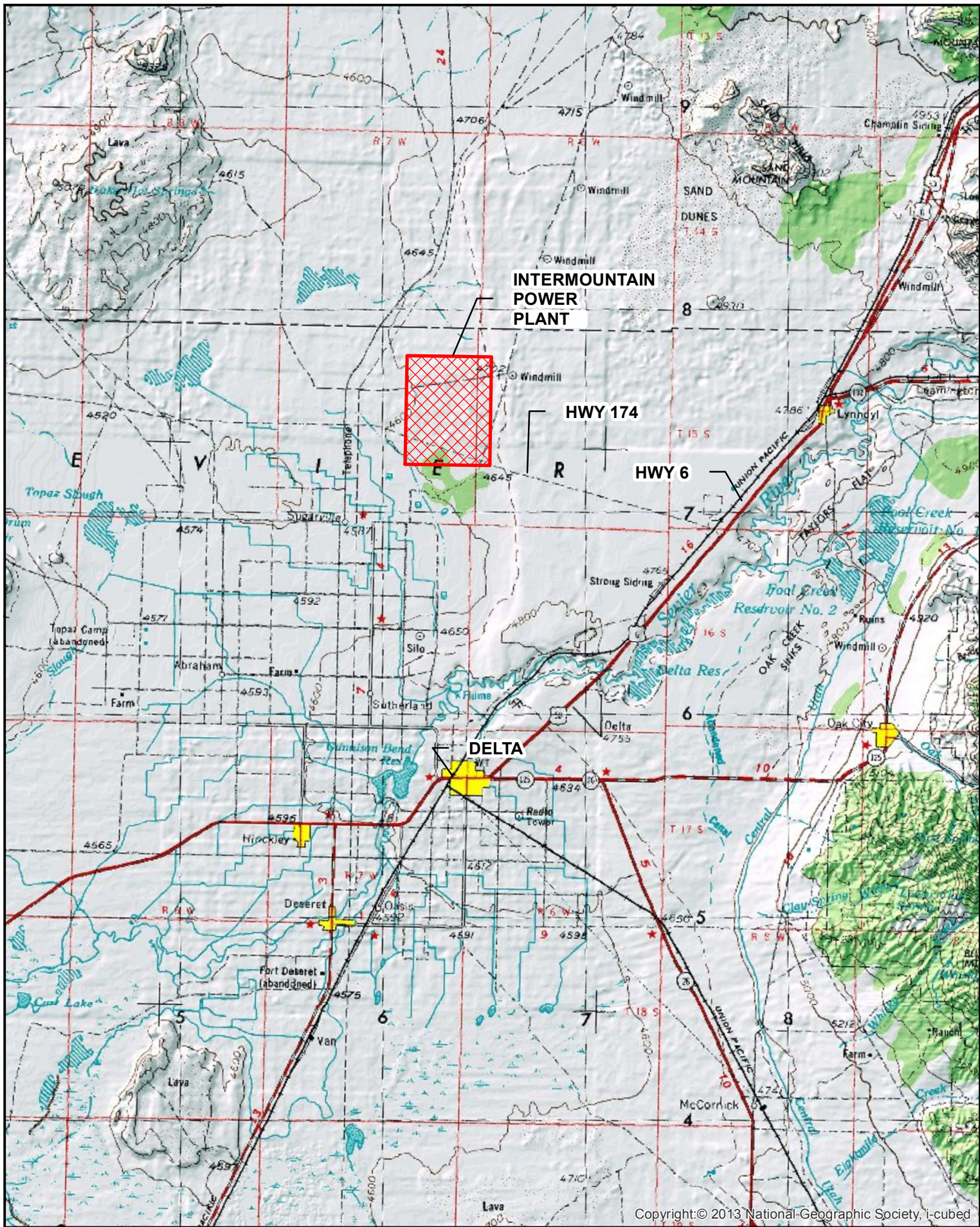

Copyright: © 2013 National Geographic Society, i-cubed

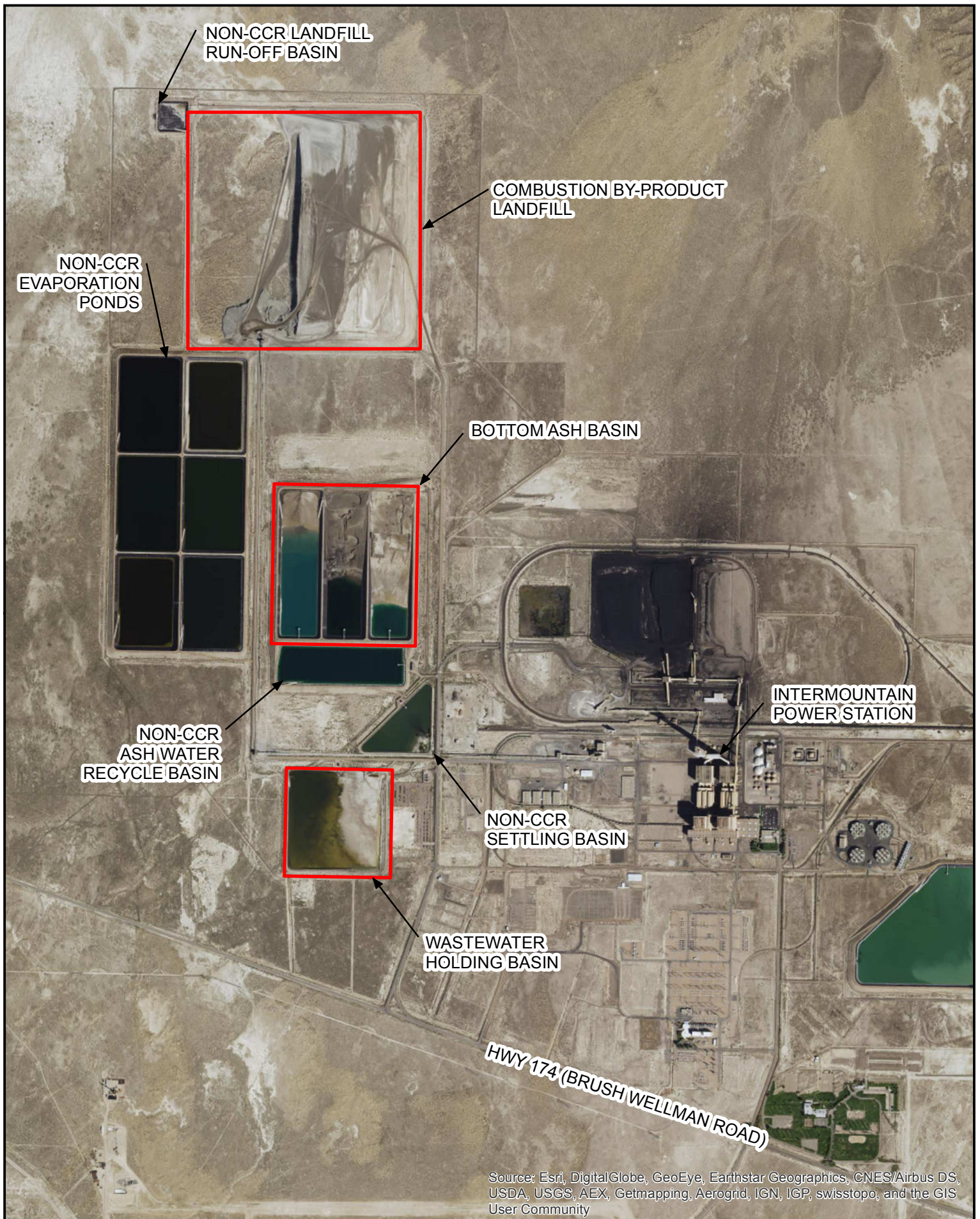

Source: Esri, DigitalGlobe, GeoEye, Earthstar Geographics, CNES/Airbus DS, USDA, USGS, AEX, Getmapping, Aerogrid, IGN, IGP, swisstopo, and the GIS User Community



**2.1 BOTTOM ASH BASIN – LINER DESIGN [257.71]**

The Bottom Ash Basin is lined with a high density polyethylene (HDPE) geomembrane. Where originally installed, the geomembrane is nominally 80 mils thick. In repaired areas, the geomembrane is 60 mils thick. This membrane rests directly on embankment material, without a discrete, underlying secondary seepage barrier component.

The upper portion of the embankment itself is fill (borrow) material derived from on-site native soils, which, based on test holes drilled in the embankment, generally consist of Clayey Sand (SC, SP-SC) and Poorly graded Sand (SP). Lower portions of the embankment consists of native, in-place (non-fill) soils, which, based on test holes drilled in the embankment, generally classify as Poorly graded Sand (SP) and Silty Sand (SM). At depth below the floor of the basin, there are various strata, including a fairly continuous layer of Sandy Lean Clay (CL).

Based on the types of soil present in the embankment, any composite behavior of soils beneath the geomembrane is anticipated to present a liquid flow rate greater than that of two feet of compacted soil with a hydraulic conductivity not exceeding  $1 \times 10^{-7}$  cm/sec. Consequently, this CCR unit is considered under Part 257 to be an existing unlined surface impoundment.

**2.2 BOTTOM ASH BASIN – STRUCTURAL INTEGRITY [257.73]****2.2.1 General [Portions of 257.73(a) through (c)]****2.2.1.1 Hazard Classification**

The Bottom Ash Basin is constructed using a combination of above ground embankment/dike and below original grade incision. Accordingly, this unit is not considered an incised CCR unit.

The Bottom Ash Basin covers approximately 105 acres and has a nominal capacity of 3,000 acre-feet without accounting for freeboard, with a maximum design depth of 46 feet (actual maximum 2016 survey depth of 47 feet).

This CCR unit classifies as a Low Hazard Potential CCR surface impoundment. This classification reflects the classification provided by the Utah Department of Natural Resources, Division of Water Rights, Dam Safety Section, which considers low hazard dams to be those dams which, if they fail, would cause minimal threat to human life, and economic losses would be minor, or limited to damage sustained by the owner of the structure. This corresponds to the Title 40, Part 257 definition of Low Hazard Potential. The classification is assessed on a periodic (5-year) basis as part of the State's inspection and review process, for which we understand a site inspection was last undertaken April 29, 2014. GCI concurs with this classification and is of the opinion that the classification is in accordance with the requirements of 257.73.

It should be noted that detailed inspections of the units are performed annually by licensed professional engineers, and routine inspections of the CCR impoundments are also performed at intervals not exceeding seven days.

With its inherently adverse high desert climate (i.e. hot dry summers and cold winters), this unit has sparse vegetation with some areas of bare earth. GCI understands that IPSC has worked to establish and re-establish this vegetation.

#### ***2.2.1.2 Additional Descriptions of Unit***

This CCR unit is owned by Intermountain Power Agency (IPA) and operated by Intermountain Power Service Corporation (IPSC). It is officially identified as Intermountain Power Bottom Ash Basin (UT00463).

This CCR unit is located approximately 11 miles north of Delta, Utah, in Millard County, Utah, at approximately latitude 39.51832 degrees North, Longitude -112.60009 degrees West, as shown in Figure 1-1. Figure 1-2 shows CCR facilities at the IPP at a larger scale.

The CCR unit is being used to dewater/decant bottom ash slurry from the boilers and the boiler area sump via settlement and evaporation.

This CCR unit is situated in the Sevier River Watershed, more specifically USGS hydrologic unit (HUC) 16030005, Lower Sevier. Per the National Resource Conservation Service (NRCS), the Lower Sevier hydrologic unit comprises approximately 4,094 square miles, or about 2,620,563 acres.

Construction records for this CCR unit are sparse. Based on available information, construction of the Intermountain Power Plant began in about September 1981. Available drawings for the facility's impoundment/ponds and embankments are dated 1983, and the unit was commissioned in 1986. It is believed that the unit was built in a single stage of construction.

As stated previously, the upper portion of the Bottom Ash Basin embankment is constructed of compacted fill (borrow) material consisting of on-site native soils which, based on test holes drilled in the embankment, generally consist of Clayey Sand (SC, SP-SC) and Poorly graded Sand (SP). The lower portion of the embankment consists of native, in-place (non-fill) soils which, based on test holes drilled in the embankment, generally classify as Poorly graded Sand (SP) and Silty Sand (SM). At depth below the floor of the basin, there are various strata, including a fairly continuous layer of Sandy Lean Clay (CL). Other than the fill and natural portions of the embankment, there appears to be no explicit zonation of materials or special foundation treatments.

Additional information regarding the physical and/or engineering properties of the materials constituting the foundation and embankment which makes up this CCR unit is provided in Section 2.2.3 of this report.

The Bottom Ash Basin is a relatively large basin, nominally 2,250 feet long and 2,050 feet wide. The Bottom Ash Basin is externally bounded by embankments having a minimum design crest width of about 20 feet (effectively 25 feet based on field observations and measurements) and approximately 3H:1V side slopes both upstream and downstream (i.e., interior and exterior). The embankments (crest Elev. 4684 feet) are approximately 45 feet tall relative to the interior floor (Elev. 4639 feet), based on

design drawings, and are a maximum of 36 feet tall relative to the east and west exteriors, based on field measurements. Field surveys indicate central portions of the basin are somewhat lower, being near Elev. 4637 feet. The south end of the Bottom Ash Basin is bounded by the adjoining non-CCR Ash Water Recycle Basin. Relative to the floor of the Ash Water Recycle Basin (which has the same nominal elevation of 4639 feet), the Bottom Ash Basin is approximately 45 feet tall. The latter height is considered to be the nominal “height” of the structure, being the vertical measurement from the downstream/exterior toe of the unit at its lowest point to the lowest elevation of the crest of the unit. The Bottom Ash Basin is internally subdivided into three sections with intermediate embankments. These embankments are contained within the overall perimeter of the Bottom Ash Basin. Elevations are based on 1929 Mean Sea Level datum, as used in the original design drawings and power plant datum.

This unit is an “off-channel” structure, built substantially above surrounding grade, and therefore only receives meteoric water and the water that is pumped into it. The unit does not receive any runoff from adjoining areas. As such, the facility is designed and operated without a spillway structure.

Inlets to each partition within the Bottom Ash Basin include four 10-inch diameter steel pipes placed on the north embankment crest that discharge directly into energy dissipation discharge structures. The energy dissipation structures consist of a 4-foot wide, 3-foot high concrete rundown structure containing several 18-inch wide baffleblocks spaced on about 3-foot centers. An outlet drop-inlet decant structure is provided at the south end of each section. The concrete descant structures are 8-foot by 14-foot- by 47-foot high (approximate dimensions), and direct water into 24-inch steel, concrete encased discharge pipes that convey fluids to the non-CCR Ash Water Recycle Basin.

Based on field surveys, the storage volume of the Bottom Ash Basin, when empty, is approximately 3000 acre-feet without accounting for approximately 3 feet of freeboard. The normal operating pool surface elevation varies depending upon CCR handling activities within the basin. The maximum normal operating pool surface elevation in one section is reported as less than 4681 feet. When this elevation is reached (or before), discharge operations switch to another section to allow for CCR dewatering and subsequent removal from the section for placement within the Combustion By-Product Landfill.

The maximum pool surface elevation following peak discharge from the inflow design flood is simply the operating pool surface elevation plus the amount of meteoric water received, as discussed hereafter in Section 2.3. We understand this elevation is maintained by standard operating procedures to be less than Elev. 4681 feet in each section.

Area-capacity curves for this CCR unit, developed by Grimshaw Surveying and provided by IPSC, are presented in Appendix C.

This CCR unit is lined with a high density polyethylene (HDPE) geomembrane, nominally 60 to 80 mils thick, depending on location. This membrane rests directly on embankment material.

Available drawing and specification excerpts from the design and construction of this unit are presented in Appendix A of this report. Additional cross-sections of the embankments, based on post-construction geotechnical studies, are presented in Section 2.2.3 and Appendix B of this report.

Existing instrumentation for this unit includes a staff gauge to monitor the water surface pool elevation in the unit and also 11 “perched” groundwater monitoring wells, located outside the embankment. These wells are used to help assess potential leakage from the lined CCR unit. Not considered part of CCR unit instrumentation, there are 24 survey monuments located along the periphery (crest) of the unit. We have considered data from these monuments in our subsequent assessment of unit stability.

Because this unit does not have spillways or diversion features, capacities and substantiating calculations are not presented herein.

To our knowledge there is no record of structural instability of this CCR unit. Additional discussion of stability is presented in Section 2.2.2.

### **2.2.2 Structural Stability Assessments [257.73(d)]**

We are of the opinion that the design, construction, operation, and maintenance of the Bottom Ash Basin is consistent with recognized and generally accepted good engineering practices, for the maximum volume of CCR and CCR waste water that can be impounded. This assessment is based on our review of construction drawings and specifications, the results of post-construction geotechnical studies, periodic observations reported by IPSC, and our own observations.

Stability of the CCR unit’s embankment and foundation soils is demonstrated by adequate factors of safety with respect to shear failure, as presented hereafter in Section 2.2.3. Stability is also demonstrated by the lack of visual distress during periodic observations, as well as minimal movement in the 24 survey settlement monuments placed along the embankment. The accuracy of these monuments placed in 2012 appears to be on the order of a couple hundredths of a foot. The largest variance observed through the four measuring events to date (including the survey tolerance) is 0.05 feet at SM9 located in the south embankment. Monuments SM21 through SM24, located along the north embankment, present an apparent settlement 0.04 feet. We consider these movements normal, resulting from the accumulation of relatively thick deposits of CCR solids in the headwaters of the basin.

Because the unit is lined with an HDPE liner, there is minimal concern regarding adverse effects of surface erosion, wave action, and adverse effects of sudden drawdown on the earthen materials inside the basin. The basin is protected at the inlet points with the aforementioned concrete energy dissipaters. External to the basin, it appears that there are regular and adequate maintenance efforts to control and otherwise prevent erosion of the embankment material.

Based on a review of construction specifications (which required compaction of at least 90% of the maximum density as determined by ASTM D 1557), as well as penetration test results obtained during post-construction geotechnical stability assessments of the

embankments, we are of the opinion that the embankments (dikes) are compacted to a density sufficient to withstand the range of loading conditions to which the CCR unit is anticipated to be subjected.

As stated previously, with its inherently adverse climate, this unit has sparse vegetation with some areas of bare earth on the exterior of the basin. GCI understands that IPSC has worked to establish and re-establish this vegetation. Other maintenance activities include the eradication of burrowing animals as needed.

As described previously, given the nature and configuration of this CCR unit, it does not have spillway or diversions. This is discussed further in Section 2.3. Due to its low hazard potential, the design flood discharge, were it applicable, would be based on a 100-year flood.

Hydraulic features passing through the CCR unit are inlet and outlet piping. Based on visual observations and reported behavior during operations, there are no indications of structural inadequacy relative to the pipes and outlet structures. Scheduled observations are made and reported by qualified persons relative to potential indicators of structural distress. Such indicators include excessive, turbid, or sediment-laden seepage; signs of piping or internal erosion; transverse or longitudinal cracking; slides, bulges, boils, sloughs, scarps, sinkholes, or depressions; abnormally high or low pool levels; animal burrows; excessive or lacking vegetative cover; slope erosion; or appearance of debris.

Apart from the south embankment, all of the downstream embankment slopes of the Bottom Ash Basin are such that they are not exposed to external bodies of water. The south embankment is common with the non-CCR ash water recycle basin. This basin is also lined, so the embankment slope is not subject to rapid-drawdown conditions. The embankment slope presents adequate factor of safety with respect to potential structural instability caused by shearing of the embankment and/or foundation soils as shown subsequently in Section 2.2.3.

### **2.2.3 “Safety Factor” Assessments [257.73(e)]**

Minimum factors of safety with respect to slope stability have been calculated for the Bottom Ash Basin using several potentially critical cross sections. These calculations were performed using a method-of-slices approach with Bishop’s simplified/modified method for evaluating both force and moment equilibrium. Failure was constrained to breaching failures, where a sufficient portion of the cross-section of the embankment slips to allow release of at least a portion of the impoundment’s contents to the surrounding area. Shallow failures are not included in these analyses as they would not result in breach or discharge of material. Both static and pseudo-static (i.e, dynamic or seismic) loading conditions were considered. A rapid drawdown case was not considered since the basin is lined.

For the seismic case, a horizontal seismic coefficient ( $k_h$ ) equal to half the peak ground acceleration for the site was used. The mapped peak ground acceleration for the site is about 0.16g (based on B/C boundary conditions), representing a 2% probability of exceedance (i.e., 98% probability of non-exceedance) in 50 years (which equates to an average return period of about 2,475 years), as reported by the USGS as part of its 2008 National Seismic Hazard Mapping Project (the most recent maps for which full hazard deaggregations are available). This value was then adjusted to 0.23g to account for local soil (site classification D) conditions. Hence, the horizontal seismic coefficient used in the analyses is 0.12. Also with respect to the seismic case, a composite Mohr-Coulomb failure envelope was also used, with drained strengths at low stresses and undrained strengths for clays at high confining stresses. Soil strengths were reduced by approximately 20 percent to account for possible soil softening caused by cyclic loading.

Additional details regarding development of strength parameters and cross-sections are presented in our original slope stability assessment report titled, "IPP Coal Combustion Waste Ponds, Geotechnical Stability Analysis Report," prepared for IPSC by Gerhart Cole Inc., and dated April 2013. The stability analyses performed for that report were reassessed for the purposes of this report.

Graphical results showing the calculated critical surfaces and factors of safety for various cross-sections are presented in Appendix B (Figure B-1 through Figure B-10), with the factors of safety also summarized on Table 2-1. As can be seen in the Table, the calculated static factors of safety under the long-term, maximum storage pool loading condition for the various potential critical sections are all at least 1.50. In the case of this unit, the maximum surcharge pool is essentially the same as the long-term maximum storage pool; consequently, separate factors of safety for the maximum surcharge pool were not calculated. The calculated seismic factor of safety for all cross-sections is at least 1.00. As such, we consider this unit stable with respect to slope stability.

Liquefaction analyses were performed using the methods of Youd et al. (2001) for granular layers located below the existing groundwater table (nominally located at a depth of 50 feet below the crest of the embankments). Test hole data representing these layers is presented in our original stability assessment report titled, "IPP Coal Combustion Waste Ponds, Geotechnical Stability Analysis Report," prepared for IPSC by Gerhart Cole Inc., and dated April 2013. The seismic analysis event was obtained from the modal event from the deaggregation previously referenced with regards to slope stability, corresponding to ground motions with a 2% probability of exceedance (i.e., 98% probability of non-exceedance) in 50 years. This event has a moment magnitude of 5.4 at a distance of about 12.3 km. (By way of comparison, the mean event magnitude is 6.1).

The minimum calculated factor of safety against triggering liquefaction was 2.5, corresponding to conditions near the northern embankment near a depth of about

50 feet. This is well in excess of the minimum 1.2 value required. It should be recognized that as performed, this analysis did not take into account the geologic age of the deposits at the critical depth; doing so would likely result in even a larger factor of safety. As such, we consider this unit stable with respect to any potential liquefaction.

### **2.3 BOTTOM ASH BASIN – HYDROLOGIC AND HYDRAULIC CAPACITY [257.82]**

For the low hazard potential classification of this unit, the inflow design flood is a 100-year event. However, as stated previously, this unit is an “off-channel” structure which is built substantially above surrounding grade, and only receives meteoric water and the water that is pumped into it. The unit does not receive runoff from adjoining areas. As such, there is no inflow design flood control system.

Per NOAA Atlas 14, Volume 1, Version 5, the precipitation event near Delta, Utah, corresponding to a 100-year, 24-hour event is 1.97 inches. Given the area of the basin together with the minimal additional contributory areas represented by adjoining roads along the crests of the embankment, we believe that this impoundment unit can readily accommodate this precipitation within the 3-foot nominal freeboard volume, and thus meet the intent of 257.82 requirements.

Table 2-1 Summary of Slope Stability Analysis Results – Bottom Ash Basin

| Scenario / Location                                    | Figure No. | Factor of Safety |         |
|--|------------|------------------|---------|
|  |            | Static           | Seismic |
| North Embankment of Bottom Ash Basin                   | B-1,B-2    | 2.54             | 1.14    |
| Southeast Corner of Bottom Ash Basin, East Embankment  | B-3,B-4    | 2.47             | 1.34    |
| Southeast Corner of Bottom Ash Basin, South Embankment | B-5,B-6    | 2.24             | 1.22    |
| Southwest Corner of Bottom Ash Basin, West Embankment  | B-7,B-8    | 2.56             | 1.39    |
| Southwest Corner of Bottom Ash Basin, South Embankment | B-9,B-10   | 2.34             | 1.28    |



**3.1 WASTE WATER BASIN – LINER DESIGN [257.71]**

The Waste Water Basin is lined with a high density polyethylene (HDPE) geomembrane. Where originally installed, the geomembrane is nominally 80 mils thick. In repaired areas, the geomembrane may be 60 mils thick. This membrane rests directly on embankment material, without a discrete, underlying secondary seepage barrier component.

The upper portion of the embankment is fill material derived from native soils, which, based on test holes drilled in the embankment, generally consist of Clayey Sand (SP-SC). The lower portion of the embankment consists of native, in-place (non-fill) soils, which, based on test holes drilled in the embankment, generally classify as Silty Sand (SM), Clayey Sand (SC), and Sandy Lean Clay (CL). At depth below the floor of the basin, there are various strata, including a rather continuous layer of Sandy Lean Clay (CL).

Based on the types of soil present in the embankment, any composite behavior of the soils beneath the geomembrane is anticipated to present a liquid flow rate greater than that of two feet of compacted soil with a hydraulic conductivity not exceeding  $1 \times 10^{-7}$  cm/sec. Consequently, this CCR unit is considered under Part 257 to be an existing unlined surface impoundment. As such, this basin is subject to the requirements of 257.101(a) which requires groundwater monitoring and/or retrofit and/or closure and/or establishment of alternative disposal capacity.

**3.2 WASTE WATER BASIN – STRUCTURAL INTEGRITY [257.73]****3.2.1 General [Portions of 257.73(a) through (c)]****3.2.1.1 Hazard Classification**

The Waste Water Basin is constructed using a combination of above ground embankment/dike and below original grade incision. Accordingly, this unit is not considered an incised CCR unit.

The Waste Water Basin, as planned, covers approximately 53 acres and has a nominal capacity of 650 acre-feet without accounting for a nominal 3 feet of freeboard, with a maximum design depth of 20 feet (actual maximum 2016 survey depth of 22 feet). A 2016 survey indicates that the actual capacity (again without freeboard) is closer to 765 acre-feet.

This CCR unit classifies as a Low Hazard Potential CCR surface impoundment. This classification reflects the classification provided by the Utah Department of Natural Resources, Division of Water Rights, Dam Safety Section, which considers low hazard dams to be those dams which, if they fail, would cause minimal threat to human life, and economic losses would be minor, or limited to damage sustained by the owner of the structure. This corresponds to the Title 40, Part 257 definition of Low Hazard Potential. The classification is assessed on a periodic (5-year) basis as part of the State's inspection and review process, for which we understand a site inspection was last undertaken April 29, 2014. GCI concurs with this classification and is of the opinion that the classification is in accordance with the requirements of 257.73.

It should be noted that detailed inspections of the units are performed annually by licensed professional engineers, and routine inspections of the CCW impoundments are also performed at intervals not exceeding seven days.

With its inherently adverse high desert climate (i.e., hot, dry summers and cold winters), this unit has sparse vegetation with some areas of bare earth. GCI understands that IPSC has worked to establish and re-establish this vegetation.

### ***3.2.1.2 Additional Descriptions of Unit***

This CCR unit is owned by Intermountain Power Agency (IPA) and operated by Intermountain Power Service Corporation (IPSC). It is officially identified as Intermountain Power Waste Water Basin (UT00468).

This CCR unit is located approximately 11 miles north of Delta, Utah, in Millard County, Utah, at approximately latitude 39.50784 degrees North, Longitude -112.60009 degrees West, as shown in Figure 1-1. Figure 1-2 shows CCR facilities at the IPP at a larger scale.

This CCR unit is being used to store waste water from various sources. During storage, CCR settles out via gravity. Water from the basin is decanted into a structure after which it is pumped either to the non-CCR Ash Water Recycle Basins or non-CCR Evaporation Ponds.

This CCR unit is situated in the Sevier River Watershed, more specifically USGS hydrologic unit (HUC) 16030005, Lower Sevier. Per the NRCS, the Lower Sevier hydrologic unit comprises approximately 4,094 square miles, or about 2,620,563 acres.

Construction records for this CCR unit are sparse. Based on available information, construction of the Intermountain Power Plant started in about September 1981. Available drawings for the facility's impoundments/ponds and embankments are dated 1983, and the unit was commissioned in 1986. It is believed that the unit was built in a single stage of construction.

As stated previously, the upper portion of the Waste Water Basin embankment consists of fill material derived from native soils, which, based on test holes drilled in the embankment, generally consist of Clayey Sand (SP-SC). The lower portion of the embankment consists of native, in-place (non-fill) soils that, based on test holes drilled in the embankment, generally classify as Silty Sand (SM), Clayey Sand (SC), and Sandy Lean Clay (CL). At depth below the floor of the basin, there are various strata, including a rather continuous layer of Sandy Lean Clay (CL). Other than the fill and natural portions of the embankment, there appears to be no explicit zonation of materials or special foundation treatments.

Additional information regarding the physical and/or engineering properties of materials constituting the foundation and embankment comprising this CCR unit is provided in Section 3.2.3 of this report.

The Waste Water Basin presents a footprint of about 1,500 feet square. The unit is bounded on all sides by embankments having a minimum design crest width of about

20 feet (effectively 25 feet based on field observations and measurements) and approximately 3H:1V side slopes both upstream and downstream (i.e., interior and exterior). The embankments (crest Elev. 4650 feet) are approximately 20 feet tall relative to the interior floor (Elev. 4630 feet) based on design drawings, and about a maximum of 12 feet tall relative to the existing ground surface, based on field measurements. Recent field surveys indicate that the central portion of the basin is somewhat lower, being near Elev. 4628 feet. The 12-foot height is considered to be the nominal “height” of the structure, being the vertical measurement from the downstream/exterior toe of the unit at its lowest point to the lowest elevation of the crest of the unit. Elevations are based on 1929 Mean Sea Level datum, as used in the original design drawings.

This unit is an “off-channel” structure that is built substantially above surrounding grade and only receives meteoric water and the water that is pumped into it. The unit does not receive any runoff from adjoining areas. As such, the facility is designed and operated without a spillway structure.

The inlet to the Waste Water Basin is a buried and submerged inlet pipeline located near the northeast corner of the basin, along the east embankment. The outlet consists of a drop-inlet structure located at the north end of the basin that feeds water to the Waste Water Basin Pump Station, where the water is subsequently pumped to other facilities.

Based on field surveys, the storage volume of the Waste Water Basin, when empty, is approximately 765 acre-feet (650 acre-feet design plan) without accounting for approximately 3 feet of freeboard. The maximum normal operating pool surface is reported as approximately Elev. 4647 feet.

The maximum pool surface elevation following peak discharge from the inflow design flood is simply the operating pool surface elevation plus the amount of meteoric water received, as discussed hereafter in Section 3.3. We understand this elevation is maintained by standard operating procedures to be less than Elev. 4647 feet.

Area-capacity curves for this CCR unit, developed by Grimshaw Surveying and provided by IPSC, are presented in Appendix C.

The CCR unit is lined with a high density polyethylene (HDPE) geomembrane, nominally 60 to 80 mils thick, depending on location. This membrane rests directly on embankment material.

Available drawing and specification excerpts from the design and construction of this unit are presented in Appendix A. Additional embankment cross-sections, based on post-construction geotechnical studies, are presented in Section 3.2.3 and Appendix B of this report.

Existing instrumentation for this unit includes a staff gauge to monitor the water surface pool elevation in the unit and also 7 “perched” groundwater monitoring wells, located outside the embankment. These wells are used to help assess potential leakage from the lined CCR unit. Not considered part of CCR unit instrumentation, there are 16

survey monuments located along the periphery (crest) of the unit. We have considered data from these monuments in our subsequent assessment of unit stability.

Because this unit does not have spillways or diversion features, capacities and substantiating calculations are not presented herein.

To our knowledge there is no record of structural instability of this CCR unit. Additional discussions of stability are presented in Section 3.2.2.

### **3.2.2 Structural Stability Assessments [257.73(d)]**

We are of the opinion that the design, construction, operation, and maintenance of the Waste Water Basin is consistent with recognized and generally accepted good engineering practices for the maximum volume of CCR and CCR waste water that can be impounded. This assessment is based on a review of construction drawings and specifications, the results of post-construction geotechnical studies, periodic observations reported by IPSC, and our own observations.

Stability of the CCR unit's embankment and foundation soils is demonstrated by adequate factors of safety with respect to shear failure, as presented hereafter in Section 3.2.3. Stability is also demonstrated by the lack of visual distress during periodic observations, as well as minimal movement in the 16 survey settlement monuments placed along the embankment. The accuracy of these monuments placed in 2012 appears to be on the order of a couple hundredths of a foot. The largest variance observed through the four measuring events to date (including the survey tolerance) is 0.07 feet at SM32 located in the south embankment. Monuments SM31 through SM35, located along the southwest quadrant of the embankment, present an apparent typical settlement 0.04 to 0.05 feet. We believe these movements are not indicative of adverse stability, but recommend continued monitoring.

Given the nature of this CCR unit, there are no abutments, hence, no comments regarding such are offered.

Because the unit is lined with an HDPE liner, there is minimal concern regarding adverse effects of surface erosion, wave action, and adverse effects of sudden drawdown. External to the basin, it appears that there are regular and adequate maintenance efforts to control and otherwise prevent erosion of the embankment material.

Based on a review of the construction specifications (which required compaction of at least 90% of the maximum density as determined by ASTM D 1557) as well as penetration test results obtained during post-construction geotechnical stability assessments of the embankments, we are of the opinion that the embankments (dikes) are compacted to a density sufficient to withstand the range of loading conditions to which the CCR unit is subjected.

As stated previously, with its inherently adverse climate, this unit has sparse vegetation with some areas of bare earth on the exterior of the basin. GCI understands that IPSC

has worked to establish and re-establish this vegetation. Other maintenance activities include the eradication of burrowing animals as needed.

As described previously, given the nature and configuration of this CCR unit, it does not have a spillway or diversions. This is discussed further in response to 257.82. Due to its low hazard potential, the design flood discharge, were it applicable, would be based on a 100-year flood.

Hydraulic features passing through the CCR units are inlet and outlet piping. Based on visual observations and reported behavior during operations, there are no indications of inadequate structural integrity. Scheduled observations are made and reported by qualified persons relative to potential indicators of structural distress. Such indicators include excessive, turbid, or sediment-laden seepage; signs of piping or internal erosion; transverse or longitudinal cracking; slides, bulges, boils, sloughs, scarps, sinkholes, or depressions; abnormally high or low pool levels; animal burrows; excessive or lacking vegetative cover; slope erosion; or appearance of debris.

All of the downstream (external) embankment slopes of the Waste Water Basin are such that they are not exposed to external bodies of water.

### **3.2.3 “Safety Factor” Assessments [257.73(e)]**

Minimum factors of safety with respect to slope stability have been calculated for the Waste Water Basin using two potentially critical cross sections. These calculations were performed using a method-of-slices approach with Bishop’s simplified/modified for evaluating both force and moment equilibrium. Failure was constrained to breaching failures, where a sufficient portion of the cross-section of the embankment slips to allow release of at least a portion of the impoundment’s contents to the surrounding area. Shallow failures are not included in these analyses as they would not result in breach or discharge of material. Both static and pseudo-static (i.e., dynamic or seismic) loading conditions were considered. A rapid drawdown case was not considered since the basin is lined.

For the seismic case, a horizontal seismic coefficient ( $k_h$ ) equal to half the peak ground acceleration for the site was used. The mapped peak ground acceleration for the site is about 0.16g (based on B/C boundary conditions), representing a 2% probability of exceedance (i.e., 98% probability of non-exceedance) in 50 years (which equates to an average return period of about 2,475 years), as reported by the USGS as part of its 2008 National Seismic Hazard Mapping Project (the most recent maps for which full hazard deaggregations are available). This value was then adjusted to 0.23g to account for local soil (site classification D) conditions. Hence, the horizontal seismic coefficient used in the analyses is 0.12. Also with respect to the seismic case, a composite Mohr-Coulomb failure envelope was also used, with drained strengths at low stresses and undrained strengths for clays at high confining stresses. Soil strengths were reduced by approximately 20 percent to account for possible soil softening caused by cyclic loading.

Additional details regarding development of strength parameters and cross-sections are presented in our original slope stability assessment report titled, "IPP Coal Combustion Waste Ponds, Geotechnical Stability Analysis Report," prepared for IPSC by Gerhart Cole Inc., and dated April 2013. The stability analyses included in that report were reassessed for the purposes of this report.

Graphical results showing the calculated critical surfaces and factors of safety for various cross-sections are presented in Appendix B (Figure B-11 through Figure B-14), with the factors of safety also summarized on Table 3-1. As can be seen in the Table, the calculated static factors of safety under the long-term, maximum storage pool loading condition for the various potential critical sections are all at least 1.50. In the case of this unit, the maximum surcharge pool is essentially the same as the long-term maximum storage pool; consequently, separate factors of safety for the maximum surcharge pool were not calculated. The calculated seismic factor of safety for all cross-sections is at least 1.00. As such, we consider this unit stable with respect to slope stability.

Liquefaction analyses were performed using the methods of Youd et al. (2001) for granular layers located below the existing groundwater table (nominally located at a depth of 28 to 30 feet below the crest of the embankments). Test hole data representing these layers is presented in our original stability assessment report titled, "IPP Coal Combustion Waste Ponds, Geotechnical Stability Analysis Report," prepared for IPSC by Gerhart Cole Inc., and dated April 2013. The seismic analysis event was obtained from the modal event from the deaggregation previously referenced with regards to slope stability, corresponding to ground motions with a 2% probability of exceedance (i.e., 98% probability of non-exceedance) in 50 years. This event has a moment magnitude of 5.4 at a distance of about 12.3 km. (By way of comparison, the mean event magnitude is 6.1).

The minimum calculated factor of safety against triggering liquefaction was 1.8, corresponding to conditions near the southern embankment near a depth of about 41 feet. This is well in excess of the minimum 1.2 value required. It should be recognized that as performed, this analysis did not take into account the geologic age of the deposits at the critical depth; doing so would likely result in even a larger factor of safety. As such, we consider this unit stable with respect to any potential liquefaction.

### **3.3 WASTE WATER BASIN – HYDROLOGIC AND HYDRAULIC CAPACITY [257.82]**

For the low hazard potential classification of this unit, the inflow design flood is a 100-year event. However, as stated previously, this unit is an "off-channel" structure which is built substantially above surrounding grade which only receives meteoric water and the water that is pumped into it. The unit does not receive runoff from adjoining areas. As such, there is no inflow design flood control system.

Per NOAA Atlas 14, Volume 1, Version 5, the precipitation event near Delta, Utah, corresponding to a 100-year, 24-hour event is 1.97 inches. Given the area of the basin (about 53 acres) together with the minimal additional contributing area presented by adjoining roads along the crests of the embankment, we believe that this impoundment unit can readily accommodate this precipitation within the 3-foot freeboard volume, and thus meet the intent of 257.82 requirements.

# SECTION THREE

## Assessments of Waste Water Basin

Table 3-1 Summary of Slope Stability Analysis Results – Waste Water Basin

| Scenario / Location                   | Figure No. | Factor of Safety |         |
|---------------------------------------|------------|------------------|---------|
|                                       |            | Static           | Seismic |
| Northwest Corner of Waste Water Basin | B-11,B-12  | 4.46             | 2.64    |
| South Embankment of Waste Water Basin | B-13,B-14  | 3.86             | 2.20    |



**4.1 COMBUSTION BY-PRODUCT LANDFILL – RUN-ON AND RUN-OFF CONTROLS [257.81]****4.1.1 GENERAL**

The CCR landfill, referred to as the Combustion By-Product Landfill, consists of approximately 271 acres with a nearly square footprint (see Figure 1-1). It is surrounded by the “Ash Truck Haul Road.” The landfill is informally divided into seven sections running north-south, each being approximately 480 feet wide. Sections are numbered 1 through 7, starting from east to west. The landfill area has been unevenly utilized, with a majority of the landfilled CCR material located in Sections 1 through 4, reaching a height of approximately 40 to 60 feet above the surrounding (original) grade. Side slopes of the landfill vary from approximately 1.3H:1V along the active west face to approximately 4 to 5H:1V along the non-active (but not closed) south, east, and north faces.

The landfill is isolated from the surrounding area by (listed in order of distance away from the landfilled CCR materials) the Ash Truck Haul Road, a drainage/containment channel, another perimeter road, and an exterior berm. The roads and channel are unpaved. The typical geometry of the drainage channel may be approximated as a trapezoid, being typically at least 4 feet deep, at least 12 feet wide at the base, and with nominal 1.5H:1V side slopes. The exterior berm is typically at least 4 to 6 feet tall and isolates the drainage channel and landfill facility from the surrounding area.

The natural slope in the vicinity of the site is approximately 0.5 to 1% down to the west and north. The drainage channel typically follows this grade. At the northwest corner of the landfill, there is the Landfill Run-off Basin into which the perimeter drainage channels from the south and east discharge. This lined basin has an approximate storage capacity of 30 acre-feet, excluding freeboard.

The surrounding area land cover may generally be described as desert shrub with a poor degree of density. Native soils in the general area are largely mapped by the USDA/SCS (U.S. Soil Conservation Service, now known as the Natural Resources Conservation Service, NRCS) as “Yenrab-Uffens complex (0 to 10% slopes)” with a lesser part of “Yenrab fine sand”. The former unit is considered to be a combination of hydrologic groups A and C, whereas the latter is hydrologic group A. Of the four possible groups of A through D, group A soils are considered to present the lowest runoff potential, and include deep sands with very little silt and clay as well as deep rapidly permeable gravel. Group C soils present a moderately high runoff potential, and include shallow soils and soils containing considerable clay and colloids with below average infiltration potential after saturation.

Per 257.81, the run-on/run-off evaluation event is a 24-hour, 25-year storm. Per NOAA Atlas 14, Volume 1, Version 5, the event near Delta, Utah, corresponding to 24-hour, 25-year storm produces 1.61 inches of precipitation.

**4.1.2 RUN-ON CONTROL**

The run-on control plan consists of isolating the landfill unit from the surrounding area, thereby preventing run-on. The landfill unit is configured such that the CCR material is placed at or above the surrounding grade. The landfill area and perimeter drainage channel are also isolated from the relatively level surrounding area by the exterior perimeter berm. Any precipitation excess is forced around the landfill area. Consequently, run-on of flow onto the CCR unit during peak discharge from the evaluation storm event is not anticipated.

**4.1.3 RUN-OFF CONTROL**

The run-off control plan consists of using the perimeter drainage channel to control precipitation run-off. As stated previously, the landfill is configured such that run-off is intercepted by the perimeter drainage channel and then conveyed to the Landfill Run-off Basin. To evaluate run-off from the landfill, a SCS-based curve number (CN) and unit hydrograph approach has been used. Based on the nature of the CCR material when placed, we have conservatively estimated the curve number to be 96, much like a dirt road or an artificial western desert landscape with a weed barrier and minimal granular cover. The calculated total runoff from the landfill under this scenario for the evaluation storm is about 27.1 acre-feet. This is less than the storage capacity of the Landfill Run-off Basin.

With respect to capacity of the drainage channel, based on a conservative Manning's 'n' value of 0.045, the calculated maximum carrying capacity is approximately 330 to 460 cfs for slopes ranging from 0.5 to 1%. Using common methods of estimating time of concentration for sheet flow, shallow concentrated flow, and channel flow (where overland flow is assumed to occur from the mid-point of the landfill, and channel length is based on the point furthest from the run-off basin), the calculated time of concentration for routing is approximately 40 minutes. Using the median temporal storm distribution from NOAA Atlas 14, Volume 1, Version 5 (general precipitation area), the 1975/1986 SCS triangular unit hydrograph approach with  $K=484$  produces a calculated peak runoff of approximately 23.0 cfs when all flow is routed to a single conveyance. Supporting calculations are provided in Appendix D. In reality, the landfill is served by at least two different conveyances – the portion of the drainage channel extending east from the run-off basin along the north and then east sides of the landfill, and the other portion of the drainage channel extending south from the run-off basin along the west and then south sides of the landfill. Given the calculated peak carrying capacity of the drainage channel is greater than the calculated peak run-off, we are of the opinion that that the run-off control system is adequate to contain the water volume resulting from the evaluation storm.

**5.1 LIMITATIONS**

The assessments and recommendations presented in this document are based on limited field studies and laboratory testing, as well as our understanding of the project's design, manner of construction, operation, and maintenance. If conditions are found later that are different from those described, we should be notified immediately so that we can make revisions as necessary.

This document was prepared solely for the use of the addressee (our Client) and may not contain sufficient information for other parties or uses.

We represent that our services are performed within the limitations prescribed by our Client, in a manner consistent with the level of care and skill ordinarily exercised by other professional consultants under similar circumstances. No other representation, expressed or implied, and no warranty or guarantee is included or intended. We do not assume responsibility for the accuracy of information provided by others.



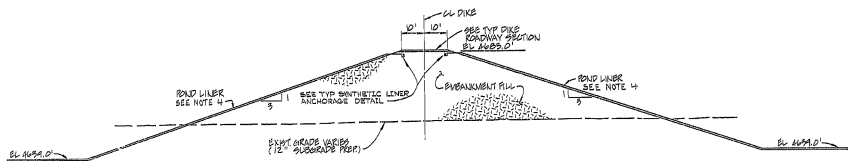

SECTION 1  
SCALE: 1"=20'

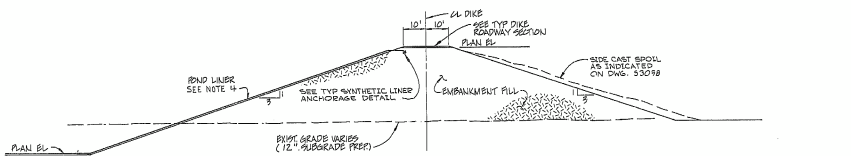

SECTION 2  
SCALE: 1"=20'

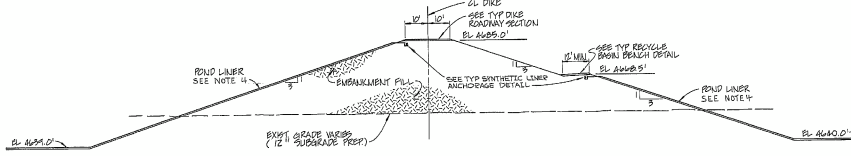

SECTION 3  
SCALE: 1"=20'

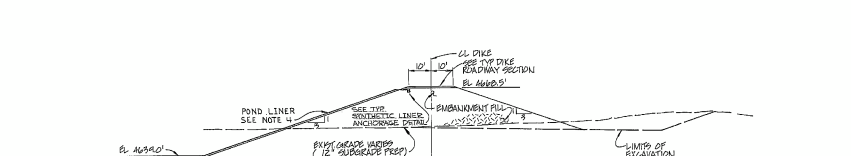

SECTION 4  
SCALE: 1"=20'

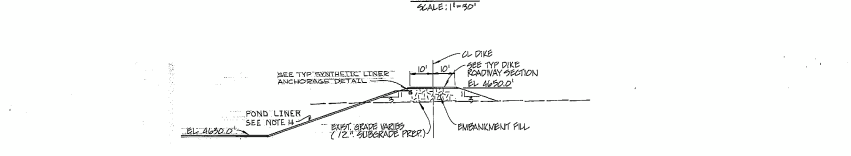

SECTION 5  
SCALE: 1"=20'

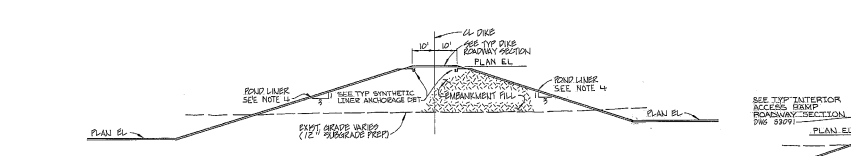

SECTION 6  
SCALE: 1"=20'

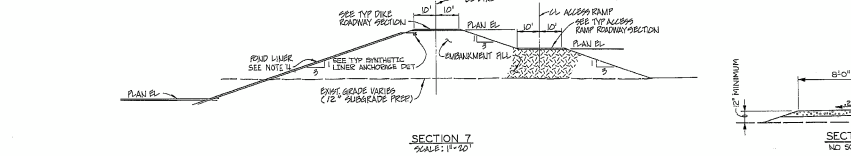

SECTION 7  
SCALE: 1"=20'

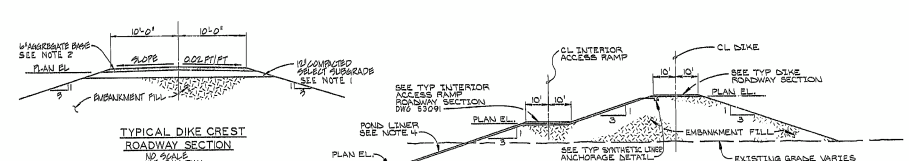

TYPICAL DIKE CREST ROADWAY SECTION  
10" SCALE  
SEE THIS DWG

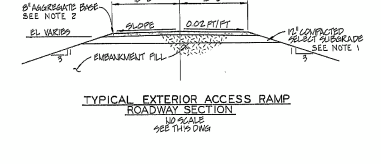

TYPICAL EXTERIOR ACCESS RAMP ROADWAY SECTION  
10" SCALE  
SEE THIS DWG

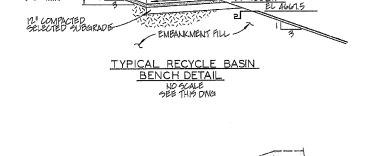

TYPICAL RECYCLE BASIN BENCH DETAIL  
10" SCALE  
SEE THIS DWG



TYPICAL SYNTHETIC LINER ANCHORAGE DETAIL  
10" SCALE  
SEE THIS DWG

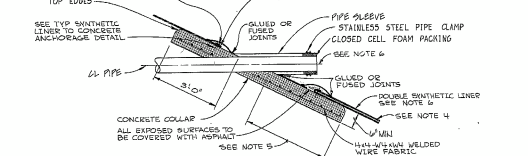

TYPICAL SYNTHETIC LINER PIPE PENETRATION DETAIL TYPE 1 & 2  
NO SCALE

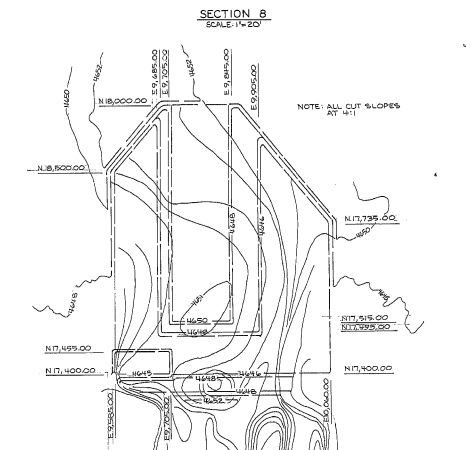

PRELIMINARY GRADING DETAIL  
ASH WATER RECYCLE BASIN  
SCALE: 1"=40'

- GENERAL NOTES**
- 12" COMPACTED SELECT SUBGRADE TO BE PLACED UNDER CONTRACT 710202.
  - AGGREGATE BASES TO BE PLACED UNDER CONTRACT 710202.
  - CEMENT STABILIZED SOIL TO BE PLACED UNDER CONTRACT 710202.
  - ALL POND LINERS EXCEPT FOR CHUTE RESERVOIR TO BE INSTALLED UNDER CONTRACT 710202. CHUTE RESERVOIR LINER SHALL BE INSTALLED UNDER CONTRACT 710202. IF A SYNTHETIC LINER IS SELECTED BY THE OWNER, CHUTE RESERVOIR LINER SHALL BE INSTALLED UNDER CONTRACT 710202. IF A CLAY LINER IS SELECTED BY THE OWNER.
  - EXTEND CONCRETE COLLAR TO TOE OF DIKE FOR TYPE 2 PIPE PENETRATION.
  - COLLAR AND DOUBLE SYNTHETIC LINER SHALL EXTEND THREE FEET EITHER SIDE OF PIPE FOR TYPE 1 AND 2 PENETRATIONS. DOUBLE LINER SHALL EXTEND TEN FEET WIDE OF SLOPE, ANCHORAGE DETAILS FOR DOUBLE SYNTHETIC LINER SHALL BE AS DETAILED BY LINER SUPPLIER.
  - SOIL-CEMENT SHALL CONSIST OF 10 PERCENT CEMENT BY WEIGHT.



REV 2 11-9-84 ISSUED FOR CONST SPEC 710202  
 REV 3 8-17-84 ISSUED FOR BIDS SPEC 710202  
 REV 4 8-18-84 ISSUED FOR CONST SPEC 710202  
 REV 1 12-7-83 ISSUED FOR BIDS SPEC 710202  
 REV 11 11-29-83 ISSUED FOR APPROX 1 SPEC 710202  
 REV 0 11-1-83 ISSUED FOR BIDS, SPEC 710202

|     |         |     |   |
|-----|---------|-----|---|
| NO. | DATE    | BY  | REVISIONS AND RECORD OF ISSUE               |
| 1   | 11-1-83 | JHV | INITIAL ISSUE                               |
| 2   | 11-2-83 | JHV | ADDEN FOR DETAIL NOTE 7. 2 DIMENSIONS       |
| 3   | 11-9-84 | JHV | REVISIONS FOR BIDDING SPEC. TO CONST. SPEC. |
| 4   | 11-9-84 | JHV | REVISIONS FOR BIDDING SPEC. TO CONST. SPEC. |
| 5   | 11-9-84 | JHV | REVISIONS FOR BIDDING SPEC. TO CONST. SPEC. |
| 6   | 11-9-84 | JHV | REVISIONS FOR BIDDING SPEC. TO CONST. SPEC. |
| 7   | 11-9-84 | JHV | REVISIONS FOR BIDDING SPEC. TO CONST. SPEC. |
| 8   | 11-9-84 | JHV | REVISIONS FOR BIDDING SPEC. TO CONST. SPEC. |
| 9   | 11-9-84 | JHV | REVISIONS FOR BIDDING SPEC. TO CONST. SPEC. |
| 10  | 11-9-84 | JHV | REVISIONS FOR BIDDING SPEC. TO CONST. SPEC. |
| 11  | 11-9-84 | JHV | REVISIONS FOR BIDDING SPEC. TO CONST. SPEC. |
| 12  | 11-9-84 | JHV | REVISIONS FOR BIDDING SPEC. TO CONST. SPEC. |
| 13  | 11-9-84 | JHV | REVISIONS FOR BIDDING SPEC. TO CONST. SPEC. |
| 14  | 11-9-84 | JHV | REVISIONS FOR BIDDING SPEC. TO CONST. SPEC. |
| 15  | 11-9-84 | JHV | REVISIONS FOR BIDDING SPEC. TO CONST. SPEC. |
| 16  | 11-9-84 | JHV | REVISIONS FOR BIDDING SPEC. TO CONST. SPEC. |
| 17  | 11-9-84 | JHV | REVISIONS FOR BIDDING SPEC. TO CONST. SPEC. |
| 18  | 11-9-84 | JHV | REVISIONS FOR BIDDING SPEC. TO CONST. SPEC. |
| 19  | 11-9-84 | JHV | REVISIONS FOR BIDDING SPEC. TO CONST. SPEC. |
| 20  | 11-9-84 | JHV | REVISIONS FOR BIDDING SPEC. TO CONST. SPEC. |

BLACK & VEATCH CONSULTING ENGINEERS  
 INTERMOUNTAIN POWER PROJECT  
 9255-9STU-S3090  
 POND AND EMBANKMENTS SECTIONS AND DETAILS  
 SCALE: AS NOTED

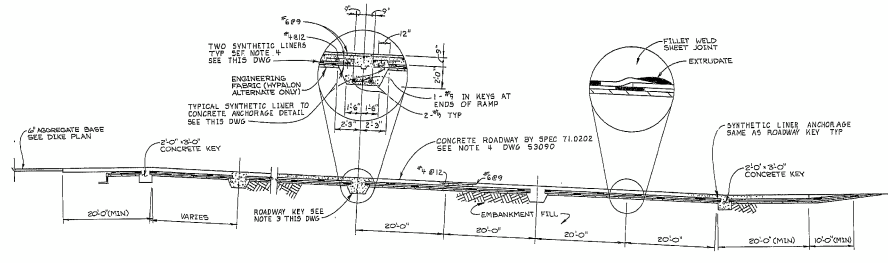

TYPICAL INTERIOR ACCESS RAMP DETAIL (SYNTHETIC LINER OPTION)  
SCALE: 1"=10'

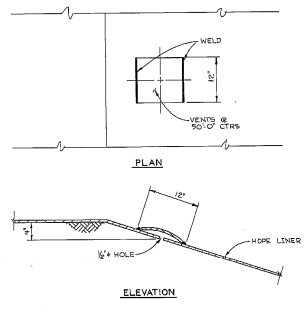

HDPE GAS VENT DETAIL  
NO SCALE  
SEE THIS DWG

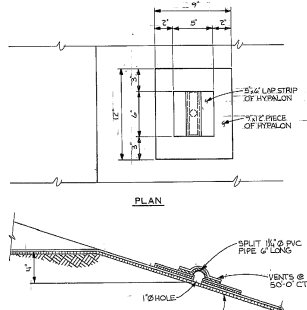

HYPALON GAS VENT DETAIL  
NO SCALE  
SEE THIS DWG

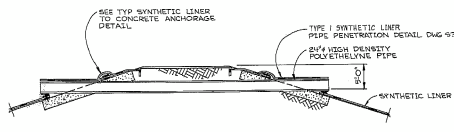

TYPICAL SYNTHETIC LINER TO CONCRETE ANCHORAGE DETAIL  
SCALE: 1"=10'

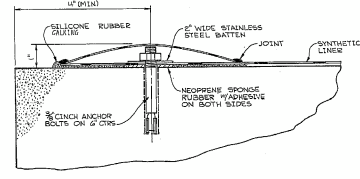

TYPICAL SYNTHETIC LINER TO CONCRETE ANCHORAGE DETAIL  
SCALE: 1"=10'

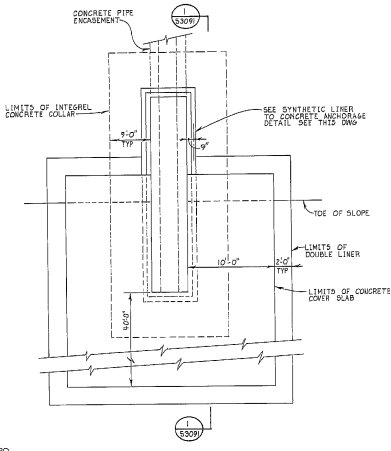

TYPE 4 SYNTHETIC LINER PIPE PENETRATION  
SCALE: 1"=1'

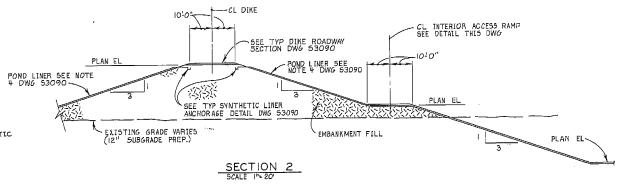

SECTION 2  
SCALE: 1"=20'

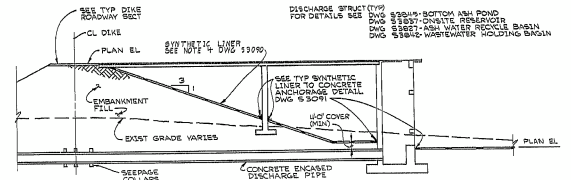

TYPICAL DISCHARGE STRUCTURE SYNTHETIC LINER DETAIL  
SCALE: 1"=20'

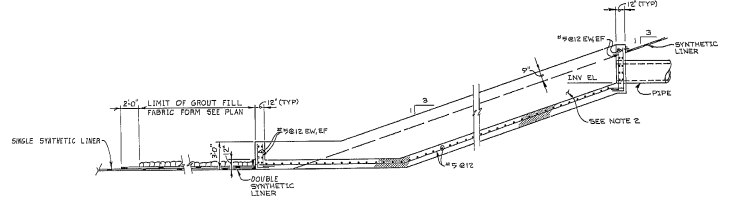

TYPICAL SYNTHETIC LINER PIPE PENETRATION TYPE 3  
NO SCALE

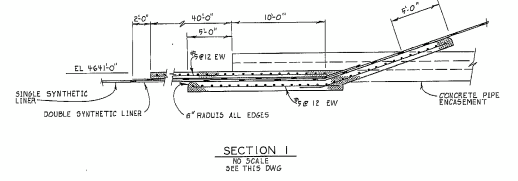

SECTION 1  
NO SCALE  
SEE THIS DWG

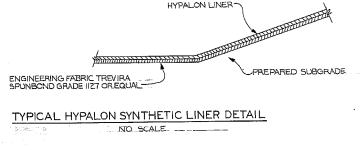

TYPICAL HYPALON SYNTHETIC LINER DETAIL  
NO SCALE

- NOTES**
1. SEE DWG 93090 FOR GENERAL NOTES.
  2. TYPE 3 PENETRATION SHALL EXTEND THREE FEET EITHER SIDE OF THE DISCHARGE PIPE.
  3. THE CONCRETE ROADWAY SHALL BE INSTALLED IN TWO POURS. THE FIRST POUR SHALL CONSIST OF THE K&S ONLY. THE SYNTHETIC LINER SHALL THEN BE PLACED ON THE RAMP AND ATTACHED TO THE K&S. THE ROADWAY SURFACE SHALL BE POURED FOLLOWING THE INSTALLATION OF THE SYNTHETIC LINER.
  4. IN ADDITION TO THE REQUIREMENTS OF THE TYPICAL ANCHORAGE DETAIL, THE SOME SIZES SHALL BE SUBVERTED BY GEOPRE STAPLE FABRIC WITH ADHESIVE ON BOTH SIDES. TWO LINES OF BATTEN STRIPS SHALL BE USED ON ALL FOUR SIDED OF THE KEY TRENCH ANCHORAGE DETAIL.



NO. 6454  
BLACK & VEATCH  
CONSULTING ENGINEERS  
STATE OF UTAH

BLACK & VEATCH CONSULTING ENGINEERS  
INTERMOUNTAIN POLLS PROJECT  
PROJECT 9255-9STU-53091  
DATE 2-23-84

| NO. | DATE    | REVISIONS AND RECORD OF ISSUE  | BY | CHECKED |
|-----|---------|--|----|---------|
| 1   | 11-1-83 | INITIAL ISSUE  | SM | SM      |
| 2   | 1-2-84  | REVISED & ADDED DETAILS & NOTES 3, 4   | SM | SM      |
| 3   | 2-23-84 | REVISED & ADDED DETAILS & NOTES 1, 2, 3, 4, 5, 6, 7, 8, 9, 10, 11, 12, 13, 14, 15, 16, 17, 18, 19, 20, 21, 22, 23, 24, 25, 26, 27, 28, 29, 30, 31, 32, 33, 34, 35, 36, 37, 38, 39, 40, 41, 42, 43, 44, 45, 46, 47, 48, 49, 50, 51, 52, 53, 54, 55, 56, 57, 58, 59, 60, 61, 62, 63, 64, 65, 66, 67, 68, 69, 70, 71, 72, 73, 74, 75, 76, 77, 78, 79, 80, 81, 82, 83, 84, 85, 86, 87, 88, 89, 90, 91, 92, 93, 94, 95, 96, 97, 98, 99, 100 | SM | SM      |
| 4   | 11-1-84 | APPROVED FOR CONST SPEC 71.0202  | SM | SM      |

SCALE: AS NOTED

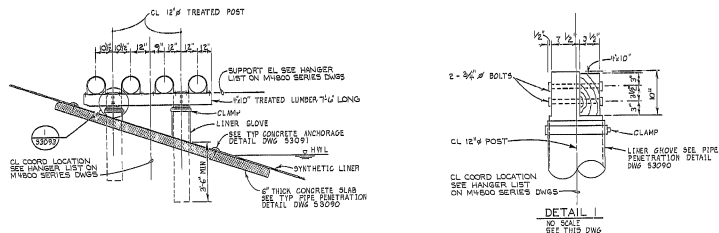

**BOTTOM ASH PIPE SUPPORT DETAIL LOOKING EAST**  
NO SCALE  
SEE THIS DWG

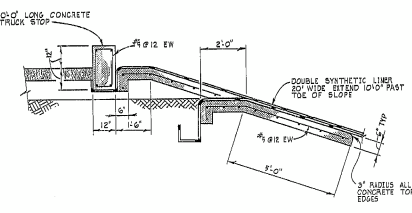

**DETAIL 2**  
NO SCALE  
SEE DWG 53098

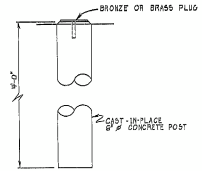

**SETTLEMENT MONUMENT**  
NO SCALE

| SETTLEMENT MONUMENT LOCATION |                  |                 |
|------------------------------|------------------|-----------------|
| MONUMENT NUMBER              | NORTH COORDINATE | EAST COORDINATE |
| SM-1                         | 15,017           | 15,080          |
| SM-2                         | 14,980           | 15,149          |
| SM-3                         | 13,191           | 15,190          |
| SM-4                         | 13,400           | 17,190          |
| SM-5                         | 14,228           | 15,000          |
| SM-6                         | 22,010           | 7,222           |
| SM-7                         | 20,190           | 6,329           |
| SM-8                         | 20,190           | 6,299           |
| SM-9                         | 17,961           | 7,322           |
| SM-10                        | 20,198           | 6,780           |
| SM-11                        | 19,320           | 10,809          |
| SM-12                        | 19,320           | 9,799           |
| SM-13                        | 19,178           | 9,780           |
| SM-14                        | 17,190           | 9,780           |

\* SEE NOTES BELOW

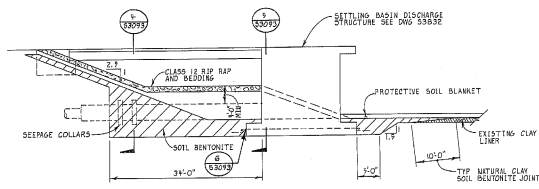

**SETTLING BASIN STRUCTURE DIKE INTERFACE**  
SCALE: 1/4\"/>

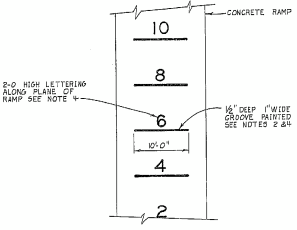

**DETAIL 3**  
NO SCALE  
SEE NOTE 2

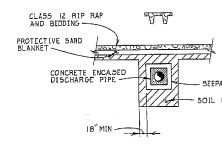

**SECTION 4**  
SCALE: 1/4\"/>

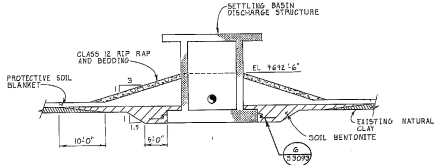

**SECTION 5**  
SCALE: 1/4\"/>

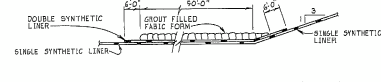

**BOTTOM ASH POND GROUT FILLED FABRIC FORM DETAIL**  
NO SCALE

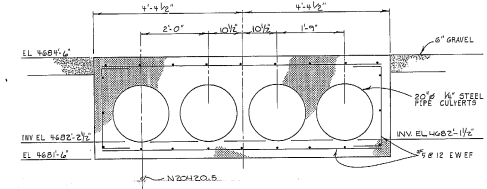

**BOTTOM ASH CULVERT DETAIL LOOKING WEST**  
(2\"/>

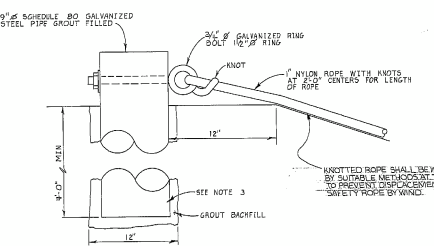

**SAFETY ROPE DETAIL**  
NO SCALE

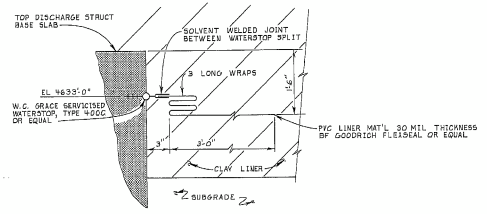

**DETAIL 6**  
NO SCALE  
SEE THIS DWG

- NOTES**
- SEE DWG 53090 FOR GENERAL NOTES
  - GRIND GROOVE AND PAINT DEPTH LEVEL EVERY 2'-0" CHANGE IN VERTICAL ELEVATION.
  - SAFETY ROPES AT 100 FEET SPACING CENTERED BETWEEN GAS VENTS ON PERIMETER OF ALL SYNTHETIC LINER PONDERS. INSTALLED BY CONTRACTOR.
  - PAINT SHALL BE A MIN 10 MILS OF CARBOLINE 199 SURFACER BELOW 8 MILS OF WHITE CARBOLINE PHENOLIC AND FASTER BACKGROUND. THE NUMBERED SHALL BE PAINTED WITH A MIN OF 5 MILS OF CARBOLINE PHENOLIC JOE, BLACK.
  - MONUMENTS SHALL BE LOCATED ON EDGE OF ASSESSMENT SURFACE ROADS, AS CLOSE AS POSSIBLE TO LISTED COORDINATES.
  - MONUMENTS SHALL BE INSTALLED AS SOON AS POSSIBLE FOLLOWING COMPLETION OF EACH RESPECTIVE EMBANKMENT TO PROPERLY MONITOR SETTLEMENT.
  - THE ELEVATION OF EACH MONUMENT SHALL BE ESTABLISHED TO THE NEAREST 0.01 FT.
  - THE CONTRACTOR SHALL SUBMIT FINAL LOCATIONS AND ELEVATIONS OF ALL MONUMENTS TO THE CONSTRUCTION MANAGER.



REV 5 11-9-94 ISSUED FOR CONST. SPEC. 71.0206  
 REV 4 8-29-94 ISSUED TO CONST. 71.0206  
 REV 3 8-17-94 ISSUED FOR CONST. SPEC. 71.0206  
 REV 2 12-16-93 ISSUED FOR ADDENDUM 2 SPEC. 71.0206  
 REV 1 11-26-93 ISSUED FOR ADDENDUM 1 SPEC. 71.0206  
 REV 0 05-22-93 ISSUED FOR REV. SPEC. 71.0207

**BLACK & VEATCH**  
CONSULTING ENGINEERS

**INTERMOUNTAIN POWER PROJECT**  
PONDERS AND EMBANKMENTS  
LINER DETAILS

PROJECT NO. 9255-95TU-S3093  
 DRAWING NUMBER 4

| NO. | DATE     | BY | DESCRIPTION                         |
|-----|----------|----|-------------------------------------|
| 1   | 11-26-93 | RA | ISSUED FOR ADDENDUM 1 SPEC. 71.0206 |
| 2   | 12-16-93 | RA | ISSUED FOR ADDENDUM 2 SPEC. 71.0206 |
| 3   | 8-17-94  | RA | ISSUED FOR CONST. SPEC. 71.0206     |
| 4   | 8-29-94  | RA | ISSUED TO CONST. 71.0206            |
| 5   | 11-9-94  | RA | ISSUED FOR CONST. SPEC. 71.0206     |

| NO. | DATE     | BY | DESCRIPTION                         |
|-----|----------|----|-------------------------------------|
| 1   | 11-26-93 | RA | ISSUED FOR ADDENDUM 1 SPEC. 71.0206 |
| 2   | 12-16-93 | RA | ISSUED FOR ADDENDUM 2 SPEC. 71.0206 |
| 3   | 8-17-94  | RA | ISSUED FOR CONST. SPEC. 71.0206     |
| 4   | 8-29-94  | RA | ISSUED TO CONST. 71.0206            |
| 5   | 11-9-94  | RA | ISSUED FOR CONST. SPEC. 71.0206     |

SCALE: 1\"/>

from borrow areas as necessary. After preparation of the fill or embankment site, the subgrade shall be scarified, leveled, and rolled so that surface materials of the subgrade will be compact and well bonded with the first layer of the fill or embankment. All material deposited in fills and embankments shall be free from rocks or stones, brush, stumps, logs, roots, debris, and organic or other objectionable materials. Fills and embankments shall be constructed in horizontal layers not exceeding 8 inches in uncompacted thickness. Material deposited in piles or windrows by excavating and hauling equipment shall be spread and leveled prior to compaction.

Each layer shall be thoroughly compacted. The compacted density of each layer shall be at least 90 per cent of the maximum density within a range of  $\pm 2$  per cent of optimum moisture content as determined by ASTM D1557. If the material fails to meet the density specified, compaction methods shall be modified as required to attain the specified density.

**2A.10 BORROW AREAS.** Material necessary to complete fills and embankments shall be excavated from borrow areas and hauled to the fill or embankment site. Borrow material will be available on the Owner's property.

The location, size, shape, depth, drainage, and surfacing of all borrow areas shall be acceptable to the Construction Manager. Borrow areas shall be regular in shape, with finish graded surfaces when completed. Side slopes shall not be steeper than three horizontal to one vertical and shall be uniform for the entire length of any one side.

**2A.11 MAINTENANCE AND RESTORATION OF FILLS AND BACKFILLS.** Fills and backfills that settle or erode before final acceptance of the work, and pavement, structures, and other facilities damaged by such settlement or erosion, shall be repaired. The settled or eroded areas shall be re-filled, compacted, and graded to conform to the elevation indicated on the drawings or to the elevation of the adjacent ground surface. Damaged facilities shall be repaired in a manner acceptable to the Construction Manager.

Earth slopes of the roads and parking areas constructed under these specifications shall be maintained to the lines and grades indicated on the drawings until the final acceptance of the roads and parking areas.

**2A.12 GRADING TO ESTABLISH FINAL GRADES.** All areas of the site shall be graded as required to establish the final grade elevations as indicated on the drawings. The grading shall be finished to the contours and elevations indicated on the drawings or, if not indicated, to the matching contours and elevations of the original, undisturbed ground surface. The final grading shall provide smooth uniform surfacing and effective drainage of the ground areas.





# Intermountain Power Station CCR Assessment

## Cross-section: North Embankment of Bottom Ash Basin Static Limit Equilibrium Analysis

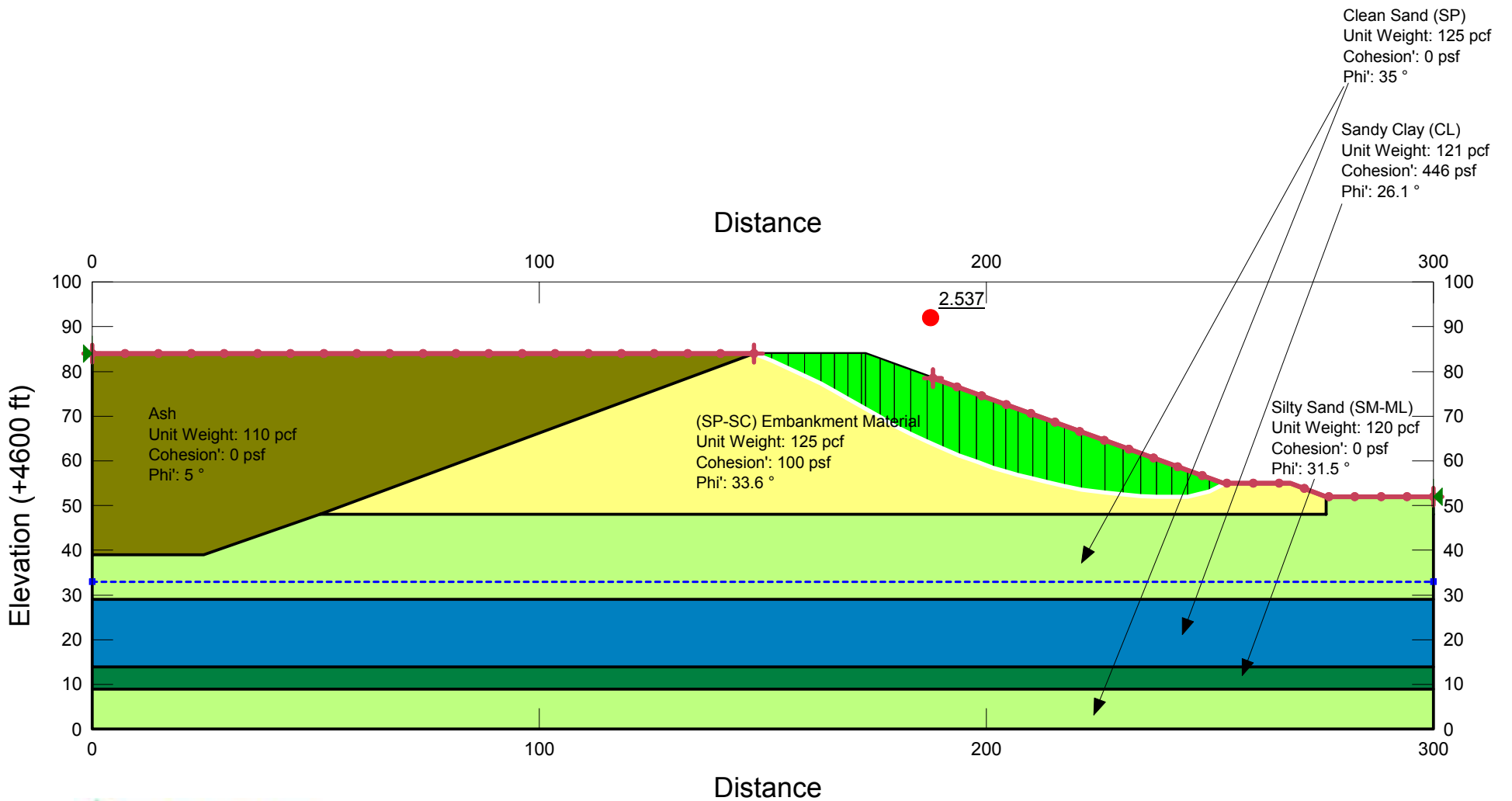

Figure B-1

# Intermountain Power Station CCR Assessment

## Cross-section: North Embankment of Bottom Ash Basin Pseudo-Dynamic Limit Equilibrium Analysis

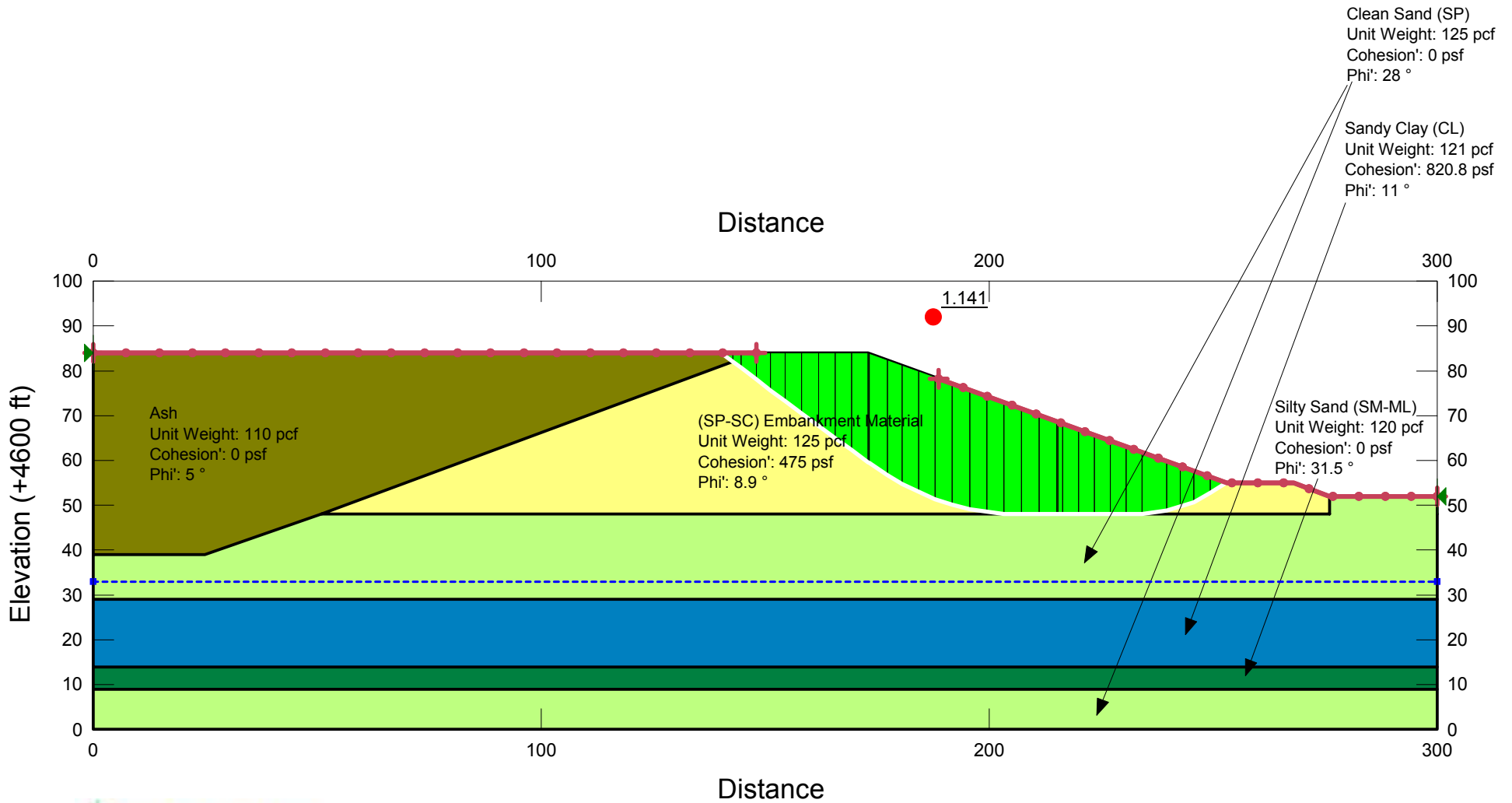

Figure B-2

# Intermountain Power Station CCR Assessment

## Cross-section: Southeast Corner of Bottom Ash Basin Static Limit Equilibrium Analysis

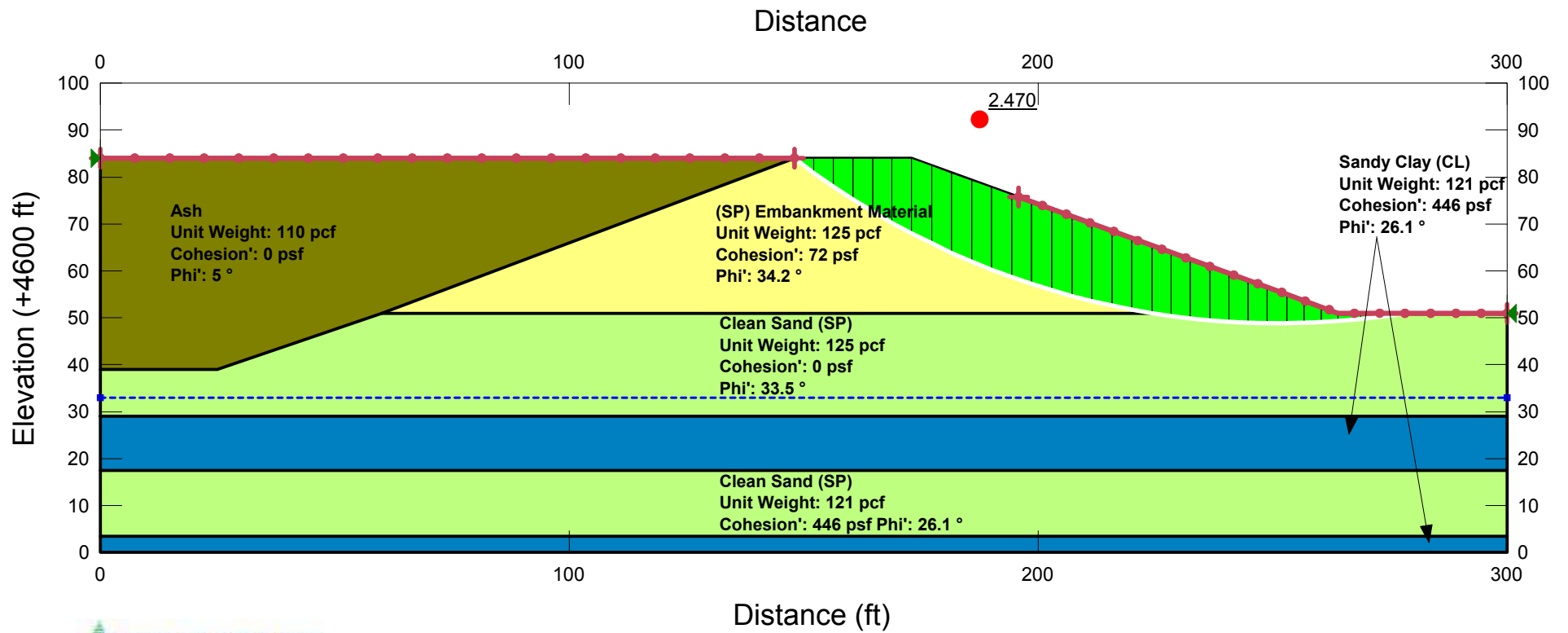

Figure B-3

# Intermountain Power Station CCR Assessment

## Cross-section: Southeast Corner of Bottom Ash Basin Pseudo-Dynamic Limit Equilibrium Analysis

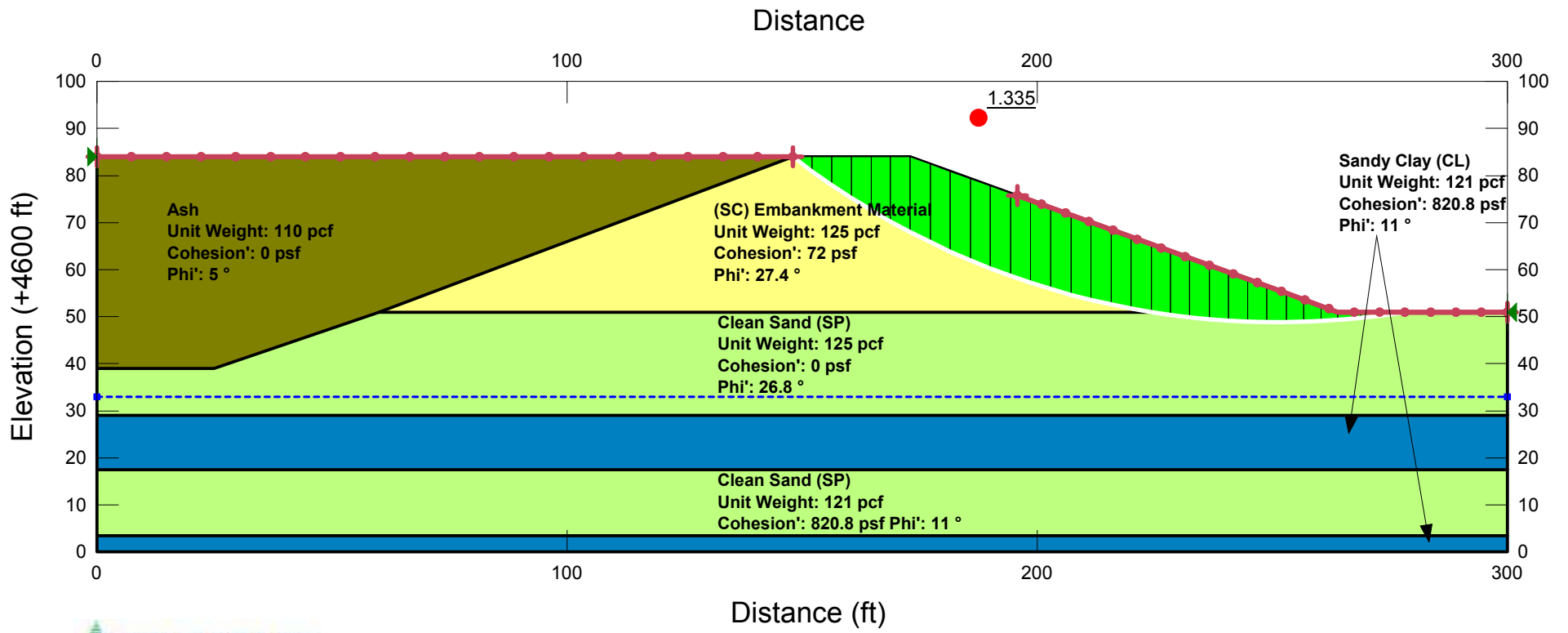

Figure B-4

# Intermountain Power Station CCR Assessment

## Cross-section: Southeast Corner of Bottom Ash Basin - South Embankment Static Limit Equilibrium Analysis

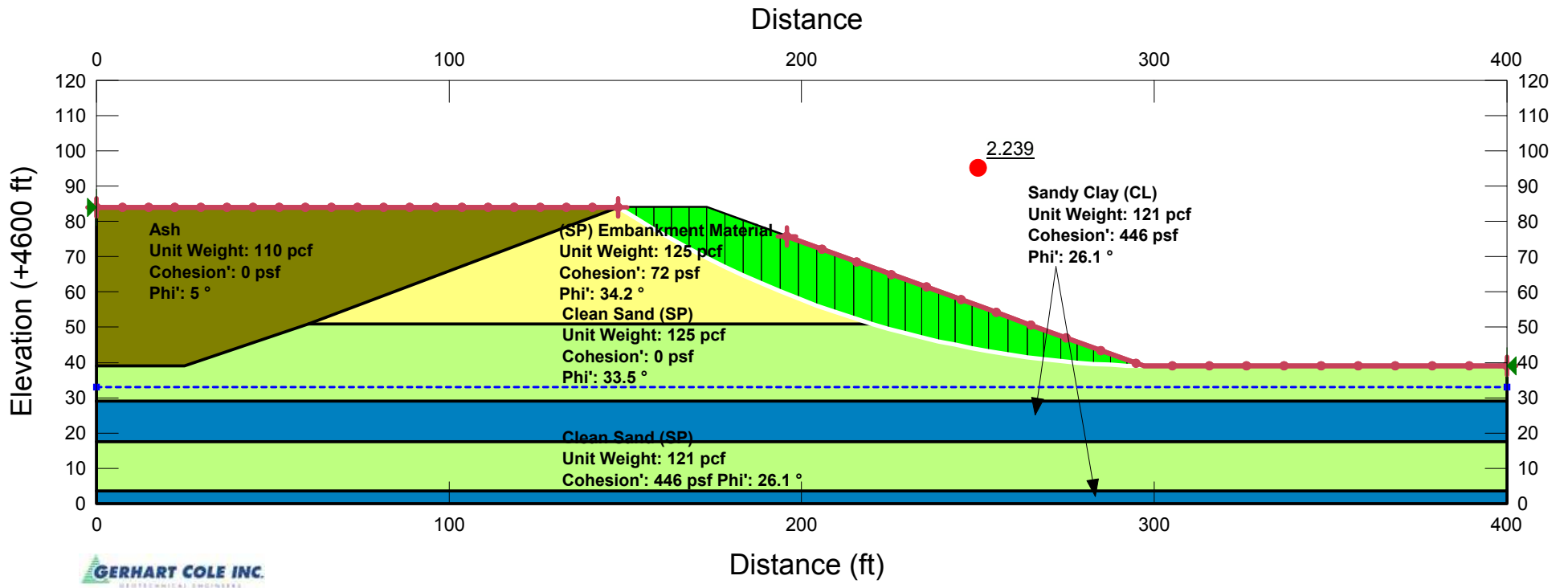

Figure B-5

# Intermountain Power Station CCR Assessment

## Cross-section: Southeast Corner of Bottom Ash Basin - South Embankment Pseudo-Dynamic Limit Equilibrium Analysis

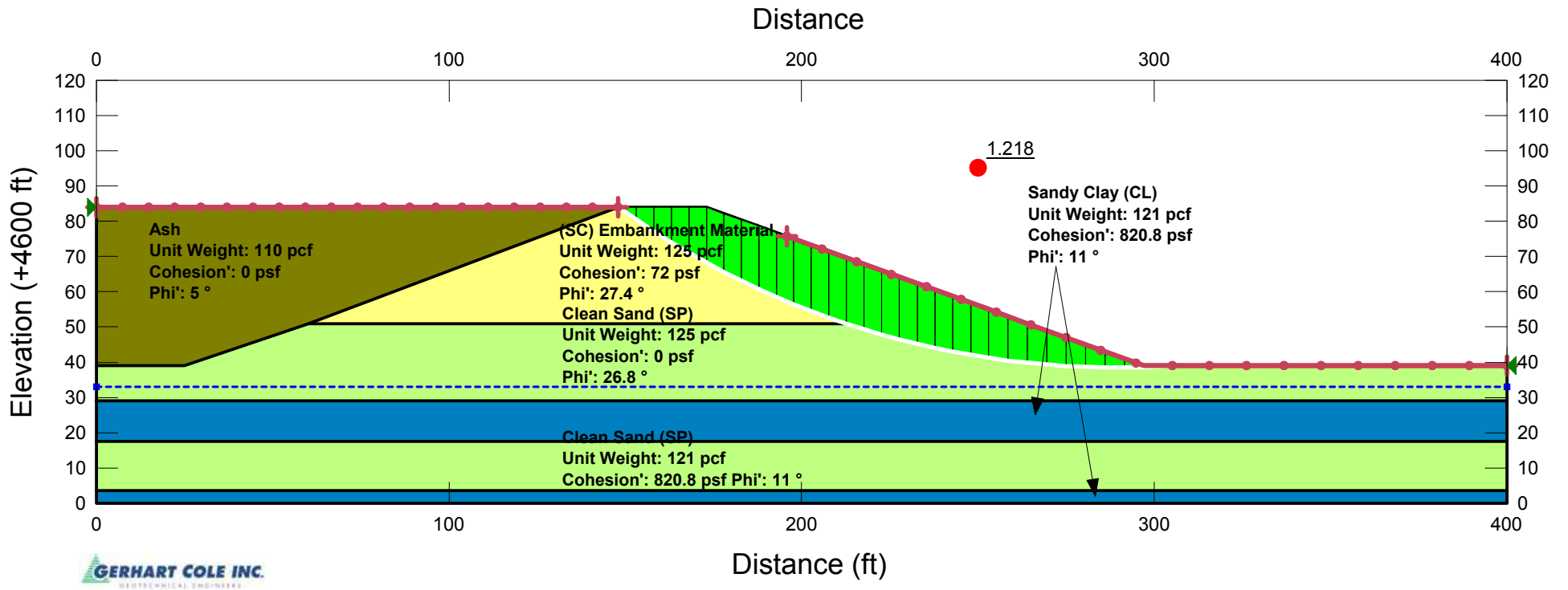

Figure B-6

# Intermountain Power Station CCR Assessment

## Cross-section: Southwest Corner of Bottom Ash Basin Static Limit Equilibrium Analysis

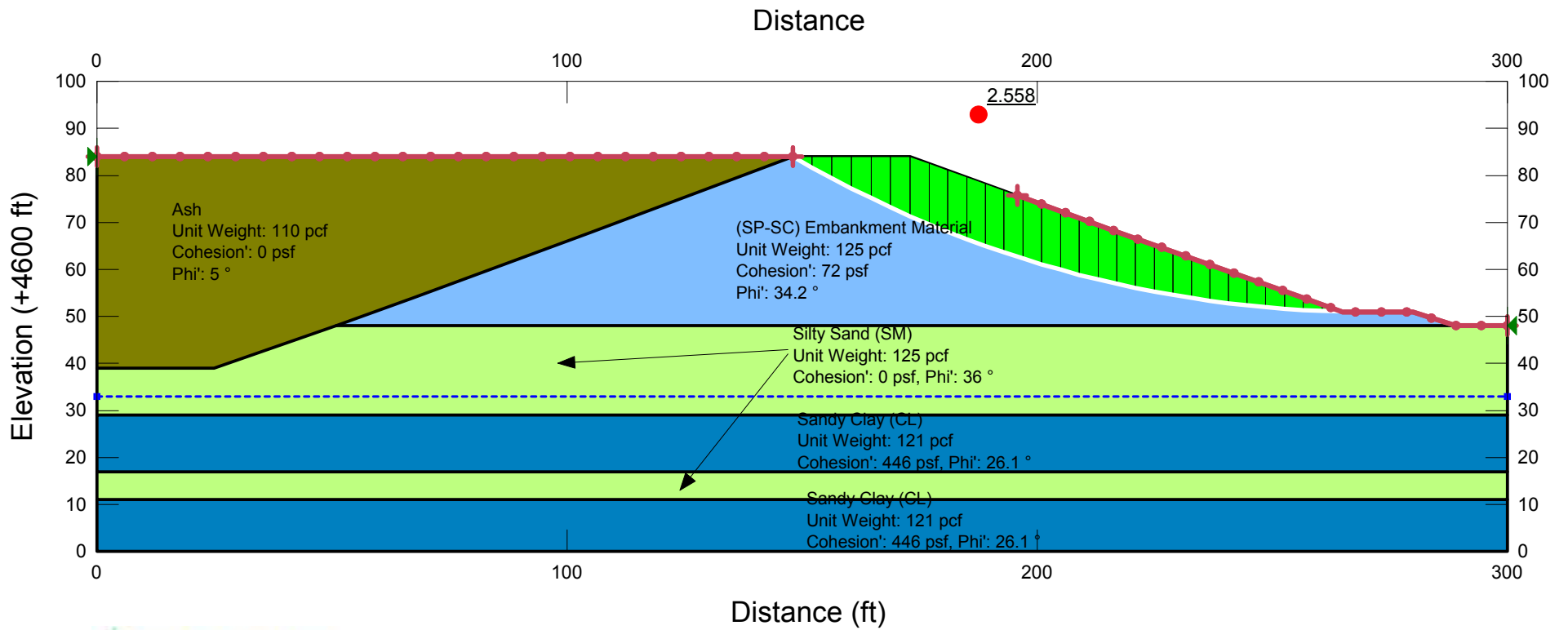

Figure B-7



# Intermountain Power Station CCR Assessment

## Cross-section: Southwest Corner of Bottom Ash Basin Pseudo-Dynamic Limit Equilibrium Analysis

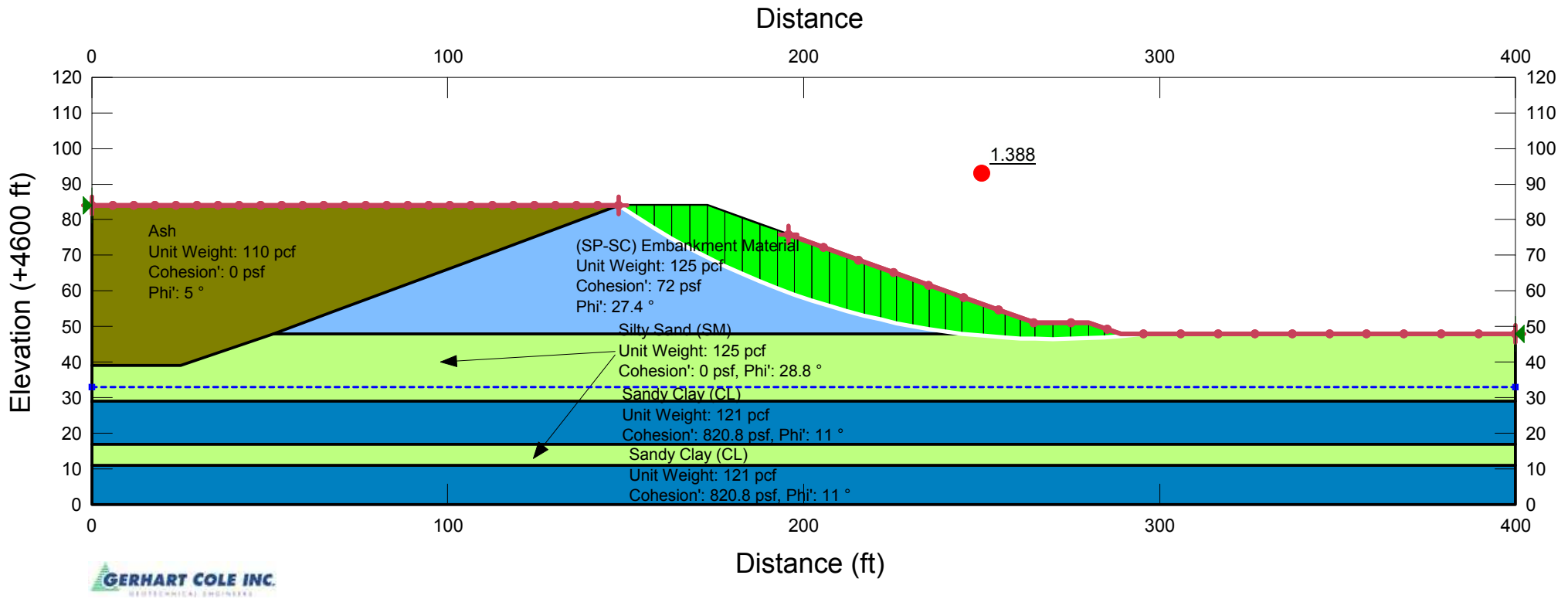

Figure B-8

# Intermountain Power Station CCR Assessment

## Cross-section: Southwest Corner of Bottom Ash Basin -South Embankment Static Limit Equilibrium Analysis

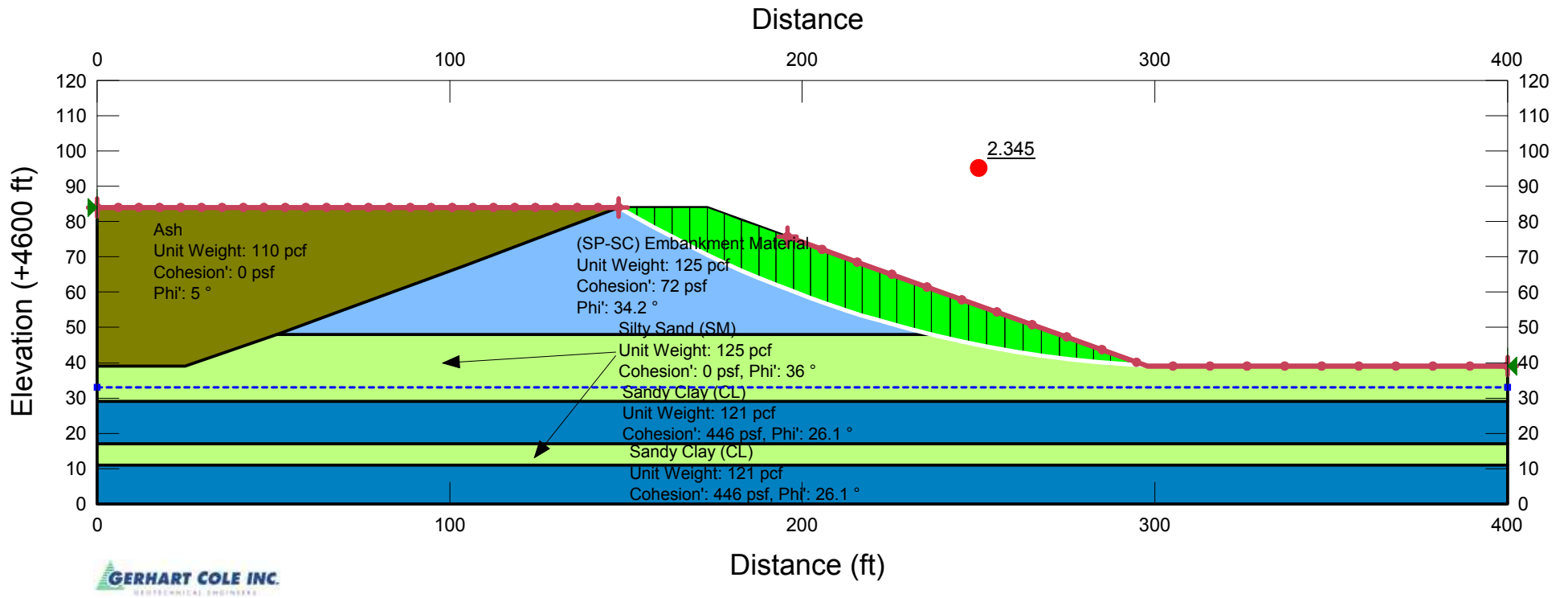

Figure B-9

# Intermountain Power Station CCR Assessment

## Cross-section: Southwest Corner of Bottom Ash Basin - South Embankment Pseudo-Dynamic Limit Equilibrium Analysis

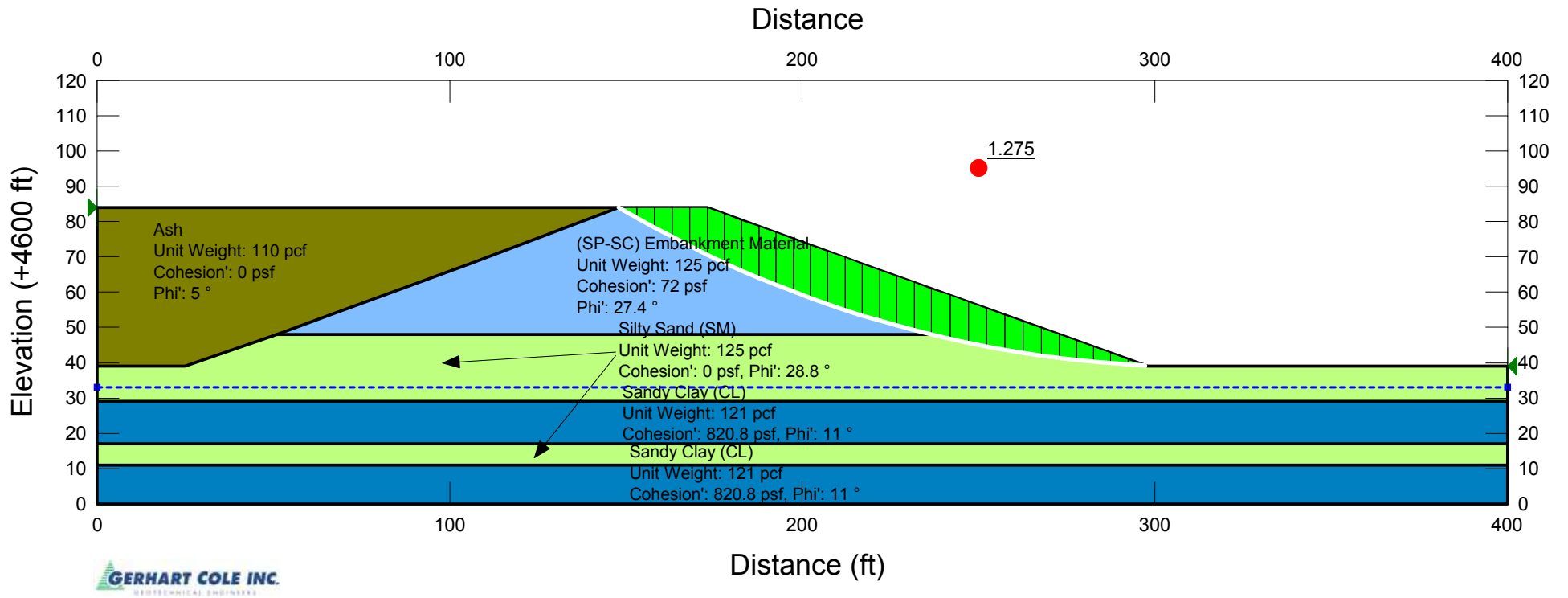
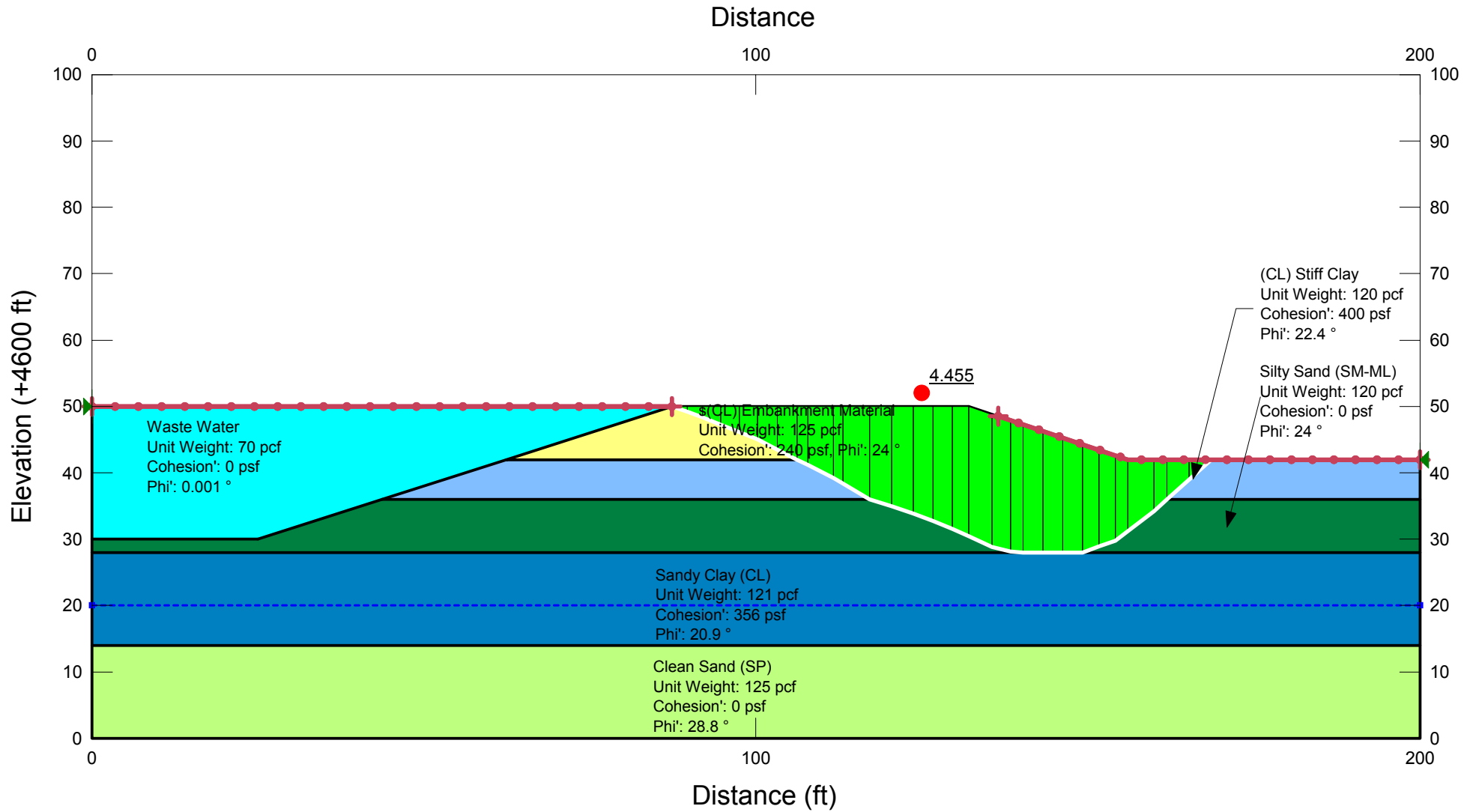

Figure B-10

# Intermountain Power Station CCR Assessment

## Cross-section: Northwest Corner of Waste Water Basin Static Limit Equilibrium Analysis



# Intermountain Power Station CCR Assessment

## Cross-section: Northwest Corner of Waste Water Basin Pseudo-Dynamic Limit Equilibrium Analysis

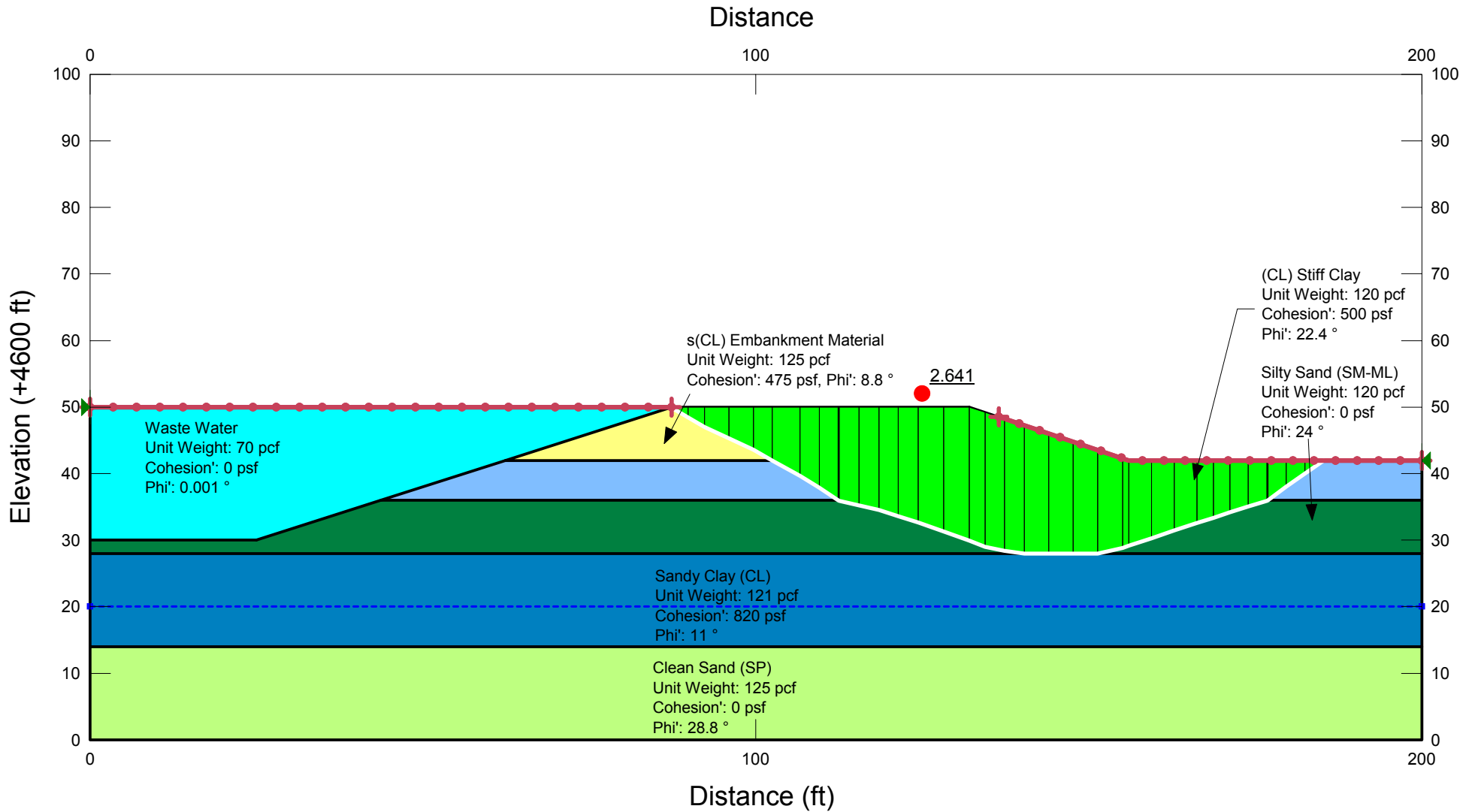

Figure B-12

# Intermountain Power Station CCR Assessment

## Cross-section: South Embankment of Waste Water Basin Static Limit Equilibrium Analysis

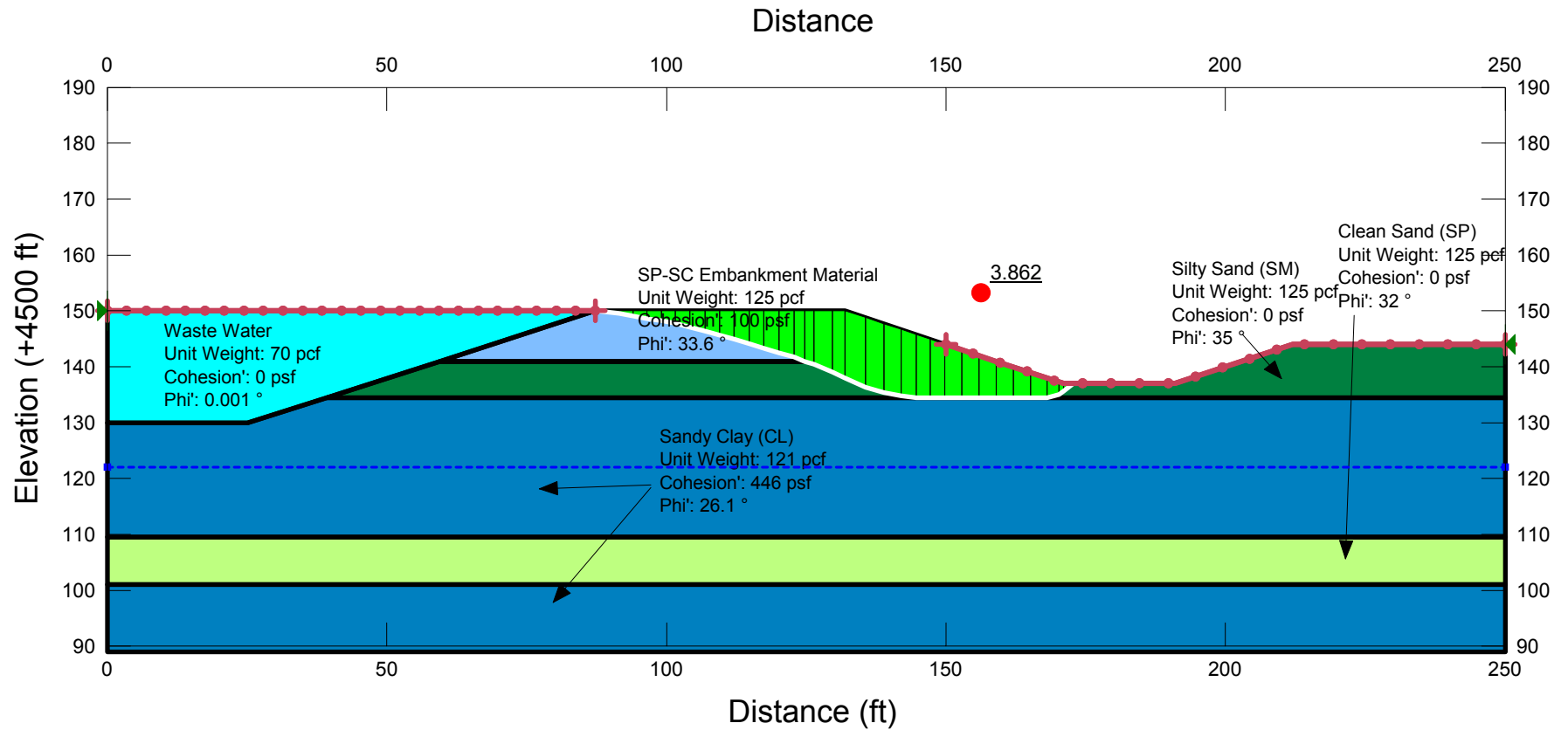

Figure B-13

**Intermountain Power Station CCR Assessment**

**Cross-section: South Embankment of Waste Water Basin  
Pseudo-Dynamic Limit Equilibrium Analysis**

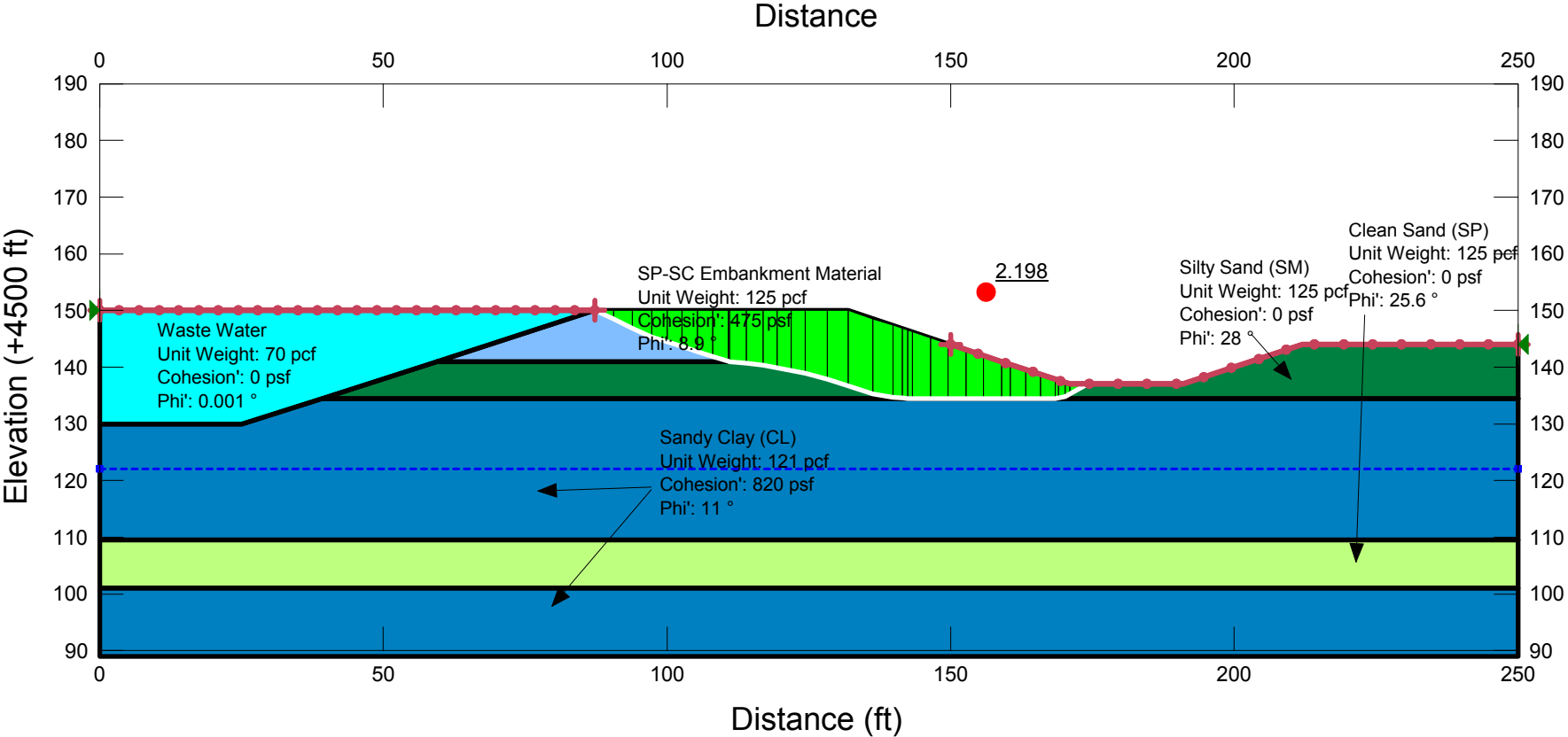

Figure B-14





### Bottom Ash Basin Capacity Table

| Contour Elevation | Water Depth | Volume in Acre Feet |
|-------------------|-------------|---------------------|
| 4684              | 47          | 3421                |
| 4682              | 45          | 3124                |
| 4680              | 43          | 2929                |
| 4678              | 41          | 2744                |
| 4676              | 39          | 2561                |
| 4674              | 37          | 2383                |
| 4672              | 35          | 2210                |
| 4670              | 33          | 2041                |
| 4668              | 31          | 1877                |
| 4666              | 29          | 1718                |
| 4664              | 27          | 1564                |
| 4662              | 25          | 1414                |
| 4660              | 23          | 1268                |
| 4658              | 21          | 1127                |
| 4656              | 19          | 990                 |
| 4654              | 17          | 858                 |
| 4652              | 15          | 729                 |
| 4650              | 13          | 606                 |
| 4648              | 11          | 486                 |
| 4646              | 9           | 371                 |
| 4644              | 7           | 260                 |
| 4642              | 5           | 153                 |
| 4640              | 3           | 50                  |
| 4637              | 0           | 0                   |

## Waste Water Basin Capacity Table

| Contour Elevation | Water Depth | Volume in Acre Feet |
|-------------------|-------------|---------------------|
| 4650              | 22          | 917                 |
| 4649              | 21          | 866                 |
| 4648              | 20          | 815                 |
| 4647              | 19          | 765                 |
| 4646              | 18          | 716                 |
| 4645              | 17          | 667                 |
| 4644              | 16          | 618                 |
| 4643              | 15          | 570                 |
| 4642              | 14          | 522                 |
| 4641              | 13          | 474                 |
| 4640              | 12          | 427                 |
| 4639              | 11          | 380                 |
| 4638              | 10          | 334                 |
| 4637              | 9           | 287                 |
| 4636              | 8           | 242                 |
| 4635              | 7           | 197                 |
| 4634              | 6           | 152                 |
| 4633              | 5           | 108                 |
| 4632              | 4           | 64                  |
| 4631              | 3           | 28                  |
| 4630              | 2           | 8.5                 |
| 4629              | 1           | 1.3                 |
| 4628              | 0           | 0                   |



**RAINFALL EXCESS CALCULATIONS**

| Rainfall Excess |           |           |           |           |            |            |            |            |              |   | L |
|-----------------|-----------|-----------|-----------|-----------|------------|------------|------------|------------|--------------|---|---|
| CN              | 96        |           |           |           |            |            |            |            |              |   |   |
| Precip (in)     | 1.61      |           |           |           |            |            |            |            |              |   |   |
| Duration (hr)   | 24        |           |           |           |            |            |            |            |              |   |   |
| Area (ac)       | 271       |           |           |           |            |            |            |            |              |   |   |
| (mi^2)          | 0.4234375 |           |           |           |            |            |            |            |              |   |   |
| S' (in)         | 0.4166667 |           |           |           |            |            |            |            |              |   |   |
|                 | Time      | Duration  | Precip    | Precip    | Cumulative | Incrementa | Cumulative | Instantane | Cumulative   |   |   |
| Increment       | (hr)      | (%)       | (%)       | (in)      | Excess, R  | Excess, R  | Excess     | Excess     | Infiltration |   |   |
|                 |           |           |           |           | (in)       | (in)       | (ac-ft)    | (in/hr)    | (in)         |   |   |
| 0               | 0         | 0         | 0         | 0         | 0          | 0          | 0          | 0          | 0            | 0 |   |
| 1               | 1         | 4.1666667 | 5         | 0.0805    | 1.94E-05   | 1.94E-05   | 0.0004381  | 1.94E-05   | 0.0804806    |   |   |
| 2               | 2         | 8.3333333 | 9.6666667 | 0.1556333 | 0.0106905  | 0.0106711  | 0.2414267  | 0.0106711  | 0.1449429    |   |   |
| 3               | 3         | 12.5      | 14.25     | 0.229425  | 0.0379253  | 0.0272348  | 0.8564795  | 0.0272348  | 0.1914997    |   |   |
| 4               | 4         | 16.666667 | 19.5      | 0.31395   | 0.082165   | 0.0442397  | 1.85556    | 0.0442397  | 0.231785     |   |   |
| 5               | 5         | 20.833333 | 25.416667 | 0.4092083 | 0.1430149  | 0.0608499  | 3.229753   | 0.0608499  | 0.2661934    |   |   |
| 6               | 6         | 25        | 30        | 0.483     | 0.1956718  | 0.0526569  | 4.4189224  | 0.0526569  | 0.2873282    |   |   |
| 7               | 7         | 29.166667 | 35.1875   | 0.5665188 | 0.2594517  | 0.0637799  | 5.8592841  | 0.0637799  | 0.3070671    |   |   |
| 8               | 8         | 33.333333 | 39.916667 | 0.6426583 | 0.3205401  | 0.0610884  | 7.2388637  | 0.0610884  | 0.3221182    |   |   |
| 9               | 9         | 37.5      | 45.125    | 0.7265125 | 0.3903204  | 0.0697803  | 8.8147355  | 0.0697803  | 0.3361921    |   |   |
| 10              | 10        | 41.666667 | 50.555556 | 0.8139444 | 0.4652688  | 0.0749484  | 10.507321  | 0.0749484  | 0.3486756    |   |   |
| 11              | 11        | 45.833333 | 55.958333 | 0.9009292 | 0.541589   | 0.0763201  | 12.230884  | 0.0763201  | 0.3593402    |   |   |
| 12              | 12        | 50        | 60.75     | 0.978075  | 0.6104602  | 0.0688713  | 13.786227  | 0.0688713  | 0.3676148    |   |   |
| 13              | 13        | 54.166667 | 65.541667 | 1.0552208 | 0.680251   | 0.0697907  | 15.362334  | 0.0697907  | 0.3749699    |   |   |
| 14              | 14        | 58.333333 | 69.944444 | 1.1261056 | 0.745063   | 0.064812   | 16.826006  | 0.064812   | 0.3810426    |   |   |
| 15              | 15        | 62.5      | 74.25     | 1.195425  | 0.8089885  | 0.0639255  | 18.269656  | 0.0639255  | 0.3864365    |   |   |
| 16              | 16        | 66.666667 | 78.555556 | 1.2647444 | 0.8733819  | 0.0643934  | 19.723875  | 0.0643934  | 0.3913625    |   |   |
| 17              | 17        | 70.833333 | 82.75     | 1.332275  | 0.9365079  | 0.0631259  | 21.149469  | 0.0631259  | 0.3957671    |   |   |
| 18              | 18        | 75        | 86.5      | 1.39265   | 0.9932368  | 0.0567289  | 22.430597  | 0.0567289  | 0.3994132    |   |   |
| 19              | 19        | 79.166667 | 90.25     | 1.453025  | 1.0502122  | 0.0569754  | 23.717292  | 0.0569754  | 0.4028128    |   |   |
| 20              | 20        | 83.333333 | 93        | 1.4973    | 1.0921366  | 0.0419245  | 24.664086  | 0.0419245  | 0.4051634    |   |   |
| 21              | 21        | 87.5      | 95.5      | 1.53755   | 1.1303463  | 0.0382097  | 25.526988  | 0.0382097  | 0.4072037    |   |   |
| 22              | 22        | 91.666667 | 97.5      | 1.56975   | 1.1609762  | 0.0306299  | 26.218713  | 0.0306299  | 0.4087738    |   |   |
| 23              | 23        | 95.833333 | 98.75     | 1.589875  | 1.1801466  | 0.0191704  | 26.651644  | 0.0191704  | 0.4097284    |   |   |
| 24              | 24        | 100       | 100       | 1.61      | 1.1993368  | 0.0191902  | 27.085022  | 0.0191902  | 0.4106632    |   |   |

### COMPOSITE RUNOFF HYDROGRAPH

(Oscillations due to discretization of 24 unit hydrographs)

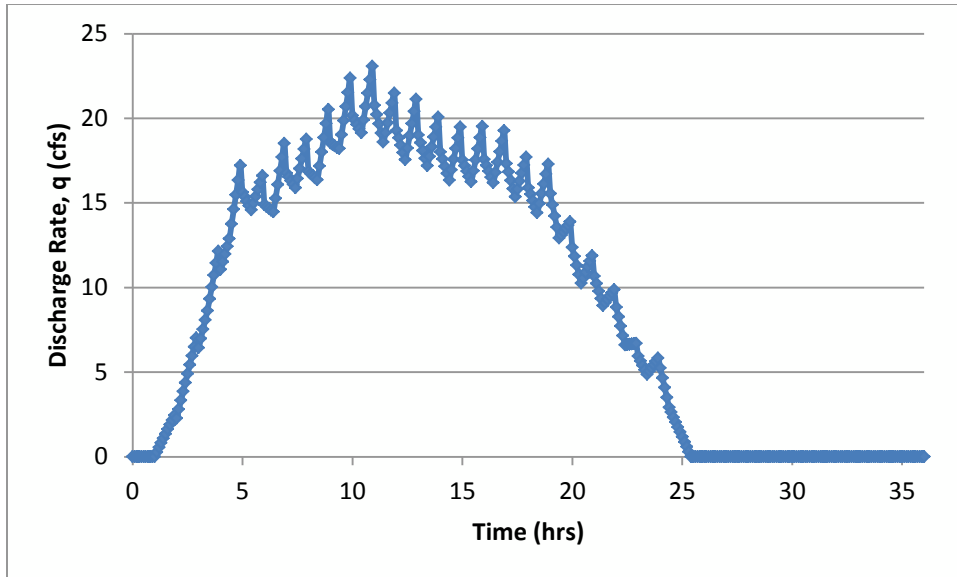

### COMPOSITE DISCHARGE CURVE

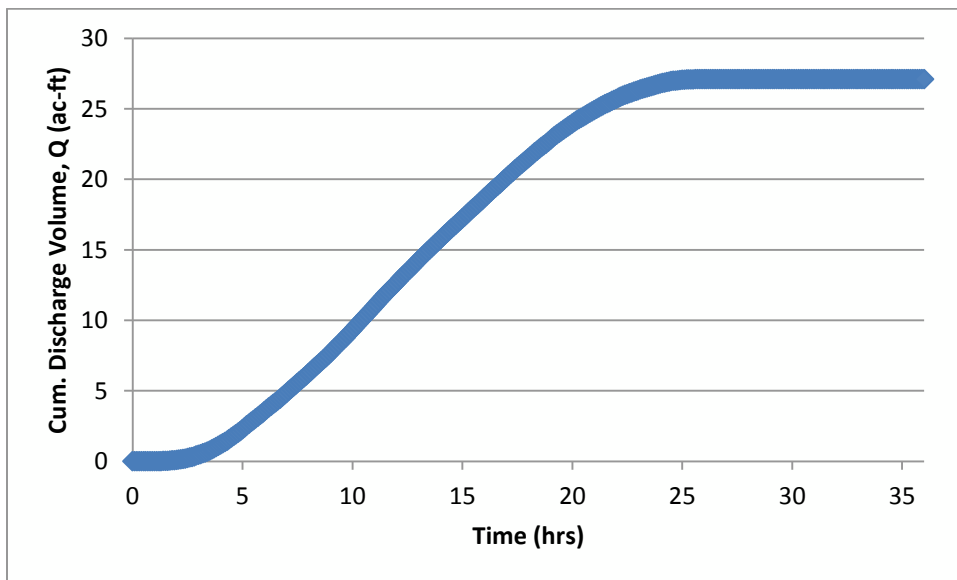

tc (hr) 0.666667  
Lag Time = 0.6 x tc (hr) 0.4

| Incremental Hydrograph #  | 1         | 2         | 3         | 4         | 5         | 6         | 7         | 8         | 9         | 10        | 11        | 12        | 13        | 14        | 15        | 16        | 17        | 18        | 19        | 20        | 21        | 22        | 23        | 24        |      |
|---------------------------|-----------|-----------|-----------|-----------|-----------|-----------|-----------|-----------|-----------|-----------|-----------|-----------|-----------|-----------|-----------|-----------|-----------|-----------|-----------|-----------|-----------|-----------|-----------|-----------|------|
| Increment                 | 0         | 1         | 2         | 3         | 4         | 5         | 6         | 7         | 8         | 9         | 10        | 11        | 12        | 13        | 14        | 15        | 16        | 17        | 18        | 19        | 20        | 21        | 22        | 23        | 24   |
| time (hr)                 | 0         | 1         | 2         | 3         | 4         | 5         | 6         | 7         | 8         | 9         | 10        | 11        | 12        | 13        | 14        | 15        | 16        | 17        | 18        | 19        | 20        | 21        | 22        | 23        | 24   |
| Time to Peak, tp (hr)     | 0.9       | 0.9       | 0.9       | 0.9       | 0.9       | 0.9       | 0.9       | 0.9       | 0.9       | 0.9       | 0.9       | 0.9       | 0.9       | 0.9       | 0.9       | 0.9       | 0.9       | 0.9       | 0.9       | 0.9       | 0.9       | 0.9       | 0.9       | 0.9       | 0.9  |
| Cum Time to Peak, tp (hr) | 0.9       | 1.9       | 2.9       | 3.9       | 4.9       | 5.9       | 6.9       | 7.9       | 8.9       | 9.9       | 10.9      | 11.9      | 12.9      | 13.9      | 14.9      | 15.9      | 16.9      | 17.9      | 18.9      | 19.9      | 20.9      | 21.9      | 22.9      | 23.9      | 24.9 |
| Excess, R (in)            | 1.94E-05  | 0.0106711 | 0.0272348 | 0.0442397 | 0.0608499 | 0.0526569 | 0.0637799 | 0.0610884 | 0.0697803 | 0.0749484 | 0.0763201 | 0.0688713 | 0.0697907 | 0.064812  | 0.0639255 | 0.0643934 | 0.0631259 | 0.0567289 | 0.0569754 | 0.0419245 | 0.0382097 | 0.0306299 | 0.0191704 | 0.0191902 |      |
| qp (cfs)                  | 0.0044174 | 2.429969  | 6.2017824 | 10.074061 | 13.856446 | 11.990791 | 14.523647 | 13.910761 | 15.890041 | 17.066906 | 17.379259 | 15.683043 | 15.892414 | 14.758689 | 14.556809 | 14.663367 | 14.374743 | 12.918044 | 12.974166 | 9.5468419 | 8.7009311 | 6.9748949 | 4.365389  | 4.3698914 |      |

| Total Time (hr) | q (cfs)   | q (cfs)   | q (cfs)   | q (cfs)   | q (cfs)   | q (cfs)   | q (cfs) | q (cfs) | q (cfs) | q (cfs) | q (cfs) | q (cfs) | q (cfs) | q (cfs) | q (cfs) | q (cfs) | q (cfs) | q (cfs) | q (cfs) | q (cfs) | q (cfs) | q (cfs) | q (cfs) | q (cfs) | Cumulative q (cfs) |
|-----------------|-----------|-----------|-----------|-----------|-----------|-----------|---------|---------|---------|---------|---------|---------|---------|---------|---------|---------|---------|---------|---------|---------|---------|---------|---------|---------|--------------------|
| 0               | 0         | 0         | 0         | 0         | 0         | 0         | 0       | 0       | 0       | 0       | 0       | 0       | 0       | 0       | 0       | 0       | 0       | 0       | 0       | 0       | 0       | 0       | 0       | 0       | 0                  |
| 0.1             | 0.0004908 | 0         | 0         | 0         | 0         | 0         | 0       | 0       | 0       | 0       | 0       | 0       | 0       | 0       | 0       | 0       | 0       | 0       | 0       | 0       | 0       | 0       | 0       | 0       | 0.0004908          |
| 0.2             | 0.0009816 | 0         | 0         | 0         | 0         | 0         | 0       | 0       | 0       | 0       | 0       | 0       | 0       | 0       | 0       | 0       | 0       | 0       | 0       | 0       | 0       | 0       | 0       | 0       | 0.0009816          |
| 0.3             | 0.0014725 | 0         | 0         | 0         | 0         | 0         | 0       | 0       | 0       | 0       | 0       | 0       | 0       | 0       | 0       | 0       | 0       | 0       | 0       | 0       | 0       | 0       | 0       | 0       | 0.0014725          |
| 0.4             | 0.0019633 | 0         | 0         | 0         | 0         | 0         | 0       | 0       | 0       | 0       | 0       | 0       | 0       | 0       | 0       | 0       | 0       | 0       | 0       | 0       | 0       | 0       | 0       | 0       | 0.0019633          |
| 0.5             | 0.0024541 | 0         | 0         | 0         | 0         | 0         | 0       | 0       | 0       | 0       | 0       | 0       | 0       | 0       | 0       | 0       | 0       | 0       | 0       | 0       | 0       | 0       | 0       | 0       | 0.0024541          |
| 0.6             | 0.0029449 | 0         | 0         | 0         | 0         | 0         | 0       | 0       | 0       | 0       | 0       | 0       | 0       | 0       | 0       | 0       | 0       | 0       | 0       | 0       | 0       | 0       | 0       | 0       | 0.0029449          |
| 0.7             | 0.0034357 | 0         | 0         | 0         | 0         | 0         | 0       | 0       | 0       | 0       | 0       | 0       | 0       | 0       | 0       | 0       | 0       | 0       | 0       | 0       | 0       | 0       | 0       | 0       | 0.0034357          |
| 0.8             | 0.0039265 | 0         | 0         | 0         | 0         | 0         | 0       | 0       | 0       | 0       | 0       | 0       | 0       | 0       | 0       | 0       | 0       | 0       | 0       | 0       | 0       | 0       | 0       | 0       | 0.0039265          |
| 0.9             | 0.0044174 | 0         | 0         | 0         | 0         | 0         | 0       | 0       | 0       | 0       | 0       | 0       | 0       | 0       | 0       | 0       | 0       | 0       | 0       | 0       | 0       | 0       | 0       | 0       | 0.0044174          |
| 1               | 0.0041229 | 0         | 0         | 0         | 0         | 0         | 0       | 0       | 0       | 0       | 0       | 0       | 0       | 0       | 0       | 0       | 0       | 0       | 0       | 0       | 0       | 0       | 0       | 0       | 0.0041229          |
| 1.1             | 0.0038284 | 0.2699966 | 0         | 0         | 0         | 0         | 0       | 0       | 0       | 0       | 0       | 0       | 0       | 0       | 0       | 0       | 0       | 0       | 0       | 0       | 0       | 0       | 0       | 0       | 0.2738249          |
| 1.2             | 0.0035339 | 0.5399931 | 0         | 0         | 0         | 0         | 0       | 0       | 0       | 0       | 0       | 0       | 0       | 0       | 0       | 0       | 0       | 0       | 0       | 0       | 0       | 0       | 0       | 0       | 0.543527           |
| 1.3             | 0.0032394 | 0.8099897 | 0         | 0         | 0         | 0         | 0       | 0       | 0       | 0       | 0       | 0       | 0       | 0       | 0       | 0       | 0       | 0       | 0       | 0       | 0       | 0       | 0       | 0       | 0.8132291          |
| 1.4             | 0.0029449 | 1.0799862 | 0         | 0         | 0         | 0         | 0       | 0       | 0       | 0       | 0       | 0       | 0       | 0       | 0       | 0       | 0       | 0       | 0       | 0       | 0       | 0       | 0       | 0       | 1.0829311          |
| 1.5             | 0.0026504 | 1.3499828 | 0         | 0         | 0         | 0         | 0       | 0       | 0       | 0       | 0       | 0       | 0       | 0       | 0       | 0       | 0       | 0       | 0       | 0       | 0       | 0       | 0       | 0       | 1.3526332          |
| 1.6             | 0.0023559 | 1.6199794 | 0         | 0         | 0         | 0         | 0       | 0       | 0       | 0       | 0       | 0       | 0       | 0       | 0       | 0       | 0       | 0       | 0       | 0       | 0       | 0       | 0       | 0       | 1.6223353          |
| 1.7             | 0.0020614 | 1.8899759 | 0         | 0         | 0         | 0         | 0       | 0       | 0       | 0       | 0       | 0       | 0       | 0       | 0       | 0       | 0       | 0       | 0       | 0       | 0       | 0       | 0       | 0       | 1.8920373          |
| 1.8             | 0.0017669 | 2.1599725 | 0         | 0         | 0         | 0         | 0       | 0       | 0       | 0       | 0       | 0       | 0       | 0       | 0       | 0       | 0       | 0       | 0       | 0       | 0       | 0       | 0       | 0       | 2.1617394          |
| 1.9             | 0.0014725 | 2.429969  | 0         | 0         | 0         | 0         | 0       | 0       | 0       | 0       | 0       | 0       | 0       | 0       | 0       | 0       | 0       | 0       | 0       | 0       | 0       | 0       | 0       | 0       | 2.4314415          |
| 2               | 0.001178  | 2.2679711 | 3.06E-15  | 0         | 0         | 0         | 0       | 0       | 0       | 0       | 0       | 0       | 0       | 0       | 0       | 0       | 0       | 0       | 0       | 0       | 0       | 0       | 0       | 0       | 2.2691491          |
| 2.1             | 0.0008835 | 2.1059732 | 0.6890869 | 0         | 0         | 0         | 0       | 0       | 0       | 0       | 0       | 0       | 0       | 0       | 0       | 0       | 0       | 0       | 0       | 0       | 0       | 0       | 0       | 0       | 2.7959436          |
| 2.2             | 0.000589  | 1.9439752 | 1.3781739 | 0         | 0         | 0         | 0       | 0       | 0       | 0       | 0       | 0       | 0       | 0       | 0       | 0       | 0       | 0       | 0       | 0       | 0       | 0       | 0       | 0       | 3.3227381          |
| 2.3             | 0.0002945 | 1.7819773 | 2.0672608 | 0         | 0         | 0         | 0       | 0       | 0       | 0       | 0       | 0       | 0       | 0       | 0       | 0       | 0       | 0       | 0       | 0       | 0       | 0       | 0       | 0       | 3.8495326          |
| 2.4             | 8.414E-06 | 1.6199794 | 2.7563477 | 0         | 0         | 0         | 0       | 0       | 0       | 0       | 0       | 0       | 0       | 0       | 0       | 0       | 0       | 0       | 0       | 0       | 0       | 0       | 0       | 0       | 4.3763355          |
| 2.5             | 0         | 1.4579814 | 3.4454347 | 0         | 0         | 0         | 0       | 0       | 0       | 0       | 0       | 0       | 0       | 0       | 0       | 0       | 0       | 0       | 0       | 0       | 0       | 0       | 0       | 0       | 4.9034161          |
| 2.6             | 0         | 1.2959835 | 4.1345216 | 0         | 0         | 0         | 0       | 0       | 0       | 0       | 0       | 0       | 0       | 0       | 0       | 0       | 0       | 0       | 0       | 0       | 0       | 0       | 0       | 0       | 5.4305051          |
| 2.7             | 0         | 1.1339855 | 4.8236085 | 0         | 0         | 0         | 0       | 0       | 0       | 0       | 0       | 0       | 0       | 0       | 0       | 0       | 0       | 0       | 0       | 0       | 0       | 0       | 0       | 0       | 5.9575941          |
| 2.8             | 0         | 0.9719876 | 5.5126955 | 0         | 0         | 0         | 0       | 0       | 0       | 0       | 0       | 0       | 0       | 0       | 0       | 0       | 0       | 0       | 0       | 0       | 0       | 0       | 0       | 0       | 6.4846831          |
| 2.9             | 0         | 0.8099897 | 6.2017824 | 0         | 0         | 0         | 0       | 0       | 0       | 0       | 0       | 0       | 0       | 0       | 0       | 0       | 0       | 0       | 0       | 0       | 0       | 0       | 0       | 0       | 7.0117721          |
| 3               | 0         | 0.6479917 | 5.7883302 | 1.491E-14 | 0         | 0         | 0       | 0       | 0       | 0       | 0       | 0       | 0       | 0       | 0       | 0       | 0       | 0       | 0       | 0       | 0       | 0       | 0       | 0       | 6.436322           |
| 3.1             | 0         | 0.4859938 | 5.3748781 | 1.1193401 | 0         | 0         | 0       | 0       | 0       | 0       | 0       | 0       | 0       | 0       | 0       | 0       | 0       | 0       | 0       | 0       | 0       | 0       | 0       | 0       | 6.980212           |
| 3.2             | 0         | 0.3239959 | 4.9614259 | 2.2386803 | 0         | 0         | 0       | 0       | 0       | 0       | 0       | 0       | 0       | 0       | 0       | 0       | 0       | 0       | 0       | 0       | 0       | 0       | 0       | 0       | 7.5241021          |
| 3.3             | 0         | 0.1619979 | 4.5479738 | 3.3580204 | 0         | 0         | 0       | 0       | 0       | 0       | 0       | 0       | 0       | 0       | 0       | 0       | 0       | 0       | 0       | 0       | 0       | 0       | 0       | 0       | 8.0679921          |
| 3.4             | 0         | 0.0046285 | 4.1345216 | 4.4773605 | 0         | 0         | 0       | 0       | 0       | 0       | 0       | 0       | 0       | 0       | 0       | 0       | 0       | 0       | 0       | 0       | 0       | 0       | 0       | 0       | 8.6165106          |
| 3.5             | 0         | 0         | 3.7210694 | 5.5967007 | 0         | 0         | 0       | 0       | 0       | 0       | 0       | 0       | 0       | 0       | 0       | 0       | 0       | 0       | 0       | 0       | 0       | 0       | 0       | 0       | 9.3177701          |
| 3.6             | 0         | 0         | 3.3076173 | 6.7160408 | 0         | 0         | 0       | 0       | 0       | 0       | 0       | 0       | 0       | 0       | 0       | 0       | 0       | 0       | 0       | 0       | 0       | 0       | 0       | 0       | 10.023658          |
| 3.7             | 0         | 0         | 2.8941651 | 7.8353809 | 0         | 0         | 0       | 0       | 0       | 0       | 0       | 0       | 0       | 0       | 0       | 0       | 0       | 0       | 0       | 0       | 0       | 0       | 0       | 0       | 10.729546          |
| 3.8             | 0         | 0         | 2.480713  | 8.9547211 | 0         | 0         | 0       | 0       | 0       | 0       | 0       | 0       | 0       | 0       | 0       | 0       | 0       | 0       | 0       | 0       | 0       | 0       | 0       | 0       | 11.435434          |
| 3.9             | 0         | 0         | 2.0672608 | 10.074061 | 0         | 0         | 0       | 0       | 0       | 0       | 0       | 0       | 0       | 0       | 0       | 0       | 0       | 0       | 0       | 0       | 0       | 0       | 0       | 0       | 12.141322          |
| 4               | 0         | 0         | 1.6538086 | 9.4024571 | 2.735E-14 | 0         | 0       | 0       | 0       | 0       | 0       | 0       | 0       | 0       | 0       | 0       | 0       | 0       | 0       | 0       | 0       | 0       | 0       | 0       | 11.056266          |
| 4.1             | 0         | 0         | 1.2403565 | 8.730853  | 1.5396051 | 0         | 0       | 0       | 0       | 0       | 0       | 0       | 0       | 0       | 0       | 0       | 0       | 0       | 0       | 0       | 0       | 0       | 0       | 0       | 11.510815          |
| 4.2             | 0         | 0         | 0.8269043 | 8.0592489 | 3.0792102 | 0         | 0       | 0       | 0       | 0       | 0       | 0       | 0       | 0       | 0       | 0       | 0       | 0       | 0       | 0       | 0       | 0       | 0       | 0       | 11.965363          |
| 4.3             | 0         | 0         | 0.4134522 | 7.3876449 | 4.6188152 | 0         | 0       | 0       | 0       | 0       | 0       | 0       | 0       | 0       | 0       | 0       | 0       | 0       | 0       | 0       | 0       | 0       | 0       | 0       | 12.419912          |
| 4.4             | 0         | 0         | 0.0118129 | 6.7160408 | 6.1584203 | 0         | 0       | 0       | 0       | 0       | 0       | 0       | 0       | 0       | 0       | 0       | 0       | 0       | 0       | 0       | 0       | 0       | 0       | 0       | 12.886274          |
| 4.5             | 0         | 0         | 0         | 6.0444367 | 7.6980254 | 0         | 0       | 0       | 0       | 0       | 0       | 0       | 0       | 0       | 0       | 0       | 0       | 0       | 0       | 0       | 0       | 0       | 0       | 0       | 13.742462          |
| 4.6             | 0         | 0         | 0         | 5.3728326 | 9.2376305 | 0         | 0       | 0       | 0       | 0       | 0       | 0       | 0       | 0       | 0       | 0       | 0       | 0       | 0       | 0       | 0       | 0       | 0       | 0       | 14.610463          |
| 4.7             | 0         | 0         | 0         | 4.7012286 | 10.777236 | 0         | 0       | 0       | 0       | 0       | 0       | 0       | 0       | 0       | 0       | 0       | 0       | 0       | 0       | 0       | 0       | 0       | 0       | 0       | 15.478464          |
| 4.8             | 0         | 0         | 0         | 4.0296245 | 12.316841 | 0         | 0       | 0       | 0       | 0       | 0       | 0       | 0       | 0       | 0       | 0       | 0       | 0       | 0       | 0       | 0       | 0       | 0       | 0       | 16.346465          |
| 4.9             | 0         | 0         | 0         | 3.3580204 | 13.856446 | 0         | 0       | 0       | 0       | 0       | 0       | 0       | 0       | 0       | 0       | 0       | 0       | 0       | 0       | 0       | 0       | 0       | 0       | 0       | 17.214466          |
| 5               | 0         | 0         | 0         | 2.6864163 | 12.932683 | 0         | 0       | 0       | 0       | 0       | 0       | 0       | 0       | 0       | 0       | 0       | 0       | 0       | 0       | 0       | 0       | 0       | 0       | 0       | 15.619099          |
| 5.1             | 0         | 0         | 0         | 2.0148122 | 12.00892  | 1.3323102 | 0       | 0       | 0       | 0       | 0       | 0       | 0       | 0       | 0       | 0       | 0       | 0       | 0       | 0       | 0       | 0       | 0       | 0       | 15.356042          |
| 5.2             | 0         | 0         | 0         | 1.3432082 | 11.085157 | 2.6646203 | 0       | 0       | 0       | 0       | 0       | 0       | 0       | 0       | 0       | 0       | 0       | 0       | 0       | 0       | 0       | 0       | 0       | 0       | 15.092985          |
| 5.3             | 0         | 0         | 0         | 0.6716041 | 10.161394 | 3.9969305 | 0       | 0       | 0       | 0       | 0       | 0       | 0       | 0       | 0       | 0       | 0       | 0       | 0       | 0       | 0       | 0       | 0       | 0       | 14.829928          |
| 5.4             | 0         | 0         | 0         | 0.0191887 | 9.2376305 | 5.3292407 | 0       | 0       | 0       | 0       | 0       | 0       | 0       | 0       | 0       | 0       | 0       | 0       | 0       | 0       | 0       | 0       | 0       | 0       | 14.58606           |
| 5.5             | 0         | 0         | 0         | 0         | 8.3138674 | 6.6615508 | 0       | 0       |         |         |         |         |         |         |         |         |         |         |         |         |         |         |         |         |                    |



















|      |           |           |           |           |          |           |           |           |           |           |           |           |           |           |           |           |           |           |           |           |           |           |           |   |           |
|------|-----------|-----------|-----------|-----------|----------|-----------|-----------|-----------|-----------|-----------|-----------|-----------|-----------|-----------|-----------|-----------|-----------|-----------|-----------|-----------|-----------|-----------|-----------|---|-----------|
| 18.9 | 0.0004381 | 0.2409887 | 0.6150528 | 0.9990804 | 1.374193 | 1.1891694 | 1.4403617 | 1.3795796 | 1.5758718 | 1.6925857 | 1.7235629 | 1.5553431 | 1.5761071 | 1.4636716 | 1.4436505 | 1.4542183 | 1.4255944 | 1.1088165 | 0.3956585 | 0         | 0         | 0         | 0         | 0 | 22.653944 |
| 19   | 0.0004381 | 0.2409887 | 0.6150528 | 0.9990804 | 1.374193 | 1.1891694 | 1.4403617 | 1.3795796 | 1.5758718 | 1.6925857 | 1.7235629 | 1.5553431 | 1.5761071 | 1.4636716 | 1.4436505 | 1.4542183 | 1.4255944 | 1.1530155 | 0.4825103 | 0         | 0         | 0         | 0         | 0 | 22.784995 |
| 19.1 | 0.0004381 | 0.2409887 | 0.6150528 | 0.9990804 | 1.374193 | 1.1891694 | 1.4403617 | 1.3795796 | 1.5758718 | 1.6925857 | 1.7235629 | 1.5553431 | 1.5761071 | 1.4636716 | 1.4436505 | 1.4542183 | 1.4255944 | 1.1876059 | 0.576439  | 0.0037872 | 0         | 0         | 0         | 0 | 22.917301 |
| 19.2 | 0.0004381 | 0.2409887 | 0.6150528 | 0.9990804 | 1.374193 | 1.1891694 | 1.4403617 | 1.3795796 | 1.5758718 | 1.6925857 | 1.7235629 | 1.5553431 | 1.5761071 | 1.4636716 | 1.4436505 | 1.4542183 | 1.4255944 | 1.2221964 | 0.6639342 | 0.0142019 | 0         | 0         | 0         | 0 | 23.049802 |
| 19.3 | 0.0004381 | 0.2409887 | 0.6150528 | 0.9990804 | 1.374193 | 1.1891694 | 1.4403617 | 1.3795796 | 1.5758718 | 1.6925857 | 1.7235629 | 1.5553431 | 1.5761071 | 1.4636716 | 1.4436505 | 1.4542183 | 1.4255944 | 1.2414133 | 0.7449959 | 0.032191  | 0         | 0         | 0         | 0 | 23.168069 |
| 19.4 | 0.0004381 | 0.2409887 | 0.6150528 | 0.9990804 | 1.374193 | 1.1891694 | 1.4403617 | 1.3795796 | 1.5758718 | 1.6925857 | 1.7235629 | 1.5553431 | 1.5761071 | 1.4636716 | 1.4436505 | 1.4542183 | 1.4255944 | 1.2606302 | 0.8221976 | 0.0568077 | 0         | 0         | 0         | 0 | 23.289105 |
| 19.5 | 0.0004381 | 0.2409887 | 0.6150528 | 0.9990804 | 1.374193 | 1.1891694 | 1.4403617 | 1.3795796 | 1.5758718 | 1.6925857 | 1.7235629 | 1.5553431 | 1.5761071 | 1.4636716 | 1.4436505 | 1.4542183 | 1.4255944 | 1.2702387 | 0.8929657 | 0.0889987 | 0         | 0         | 0         | 0 | 23.401672 |
| 19.6 | 0.0004381 | 0.2409887 | 0.6150528 | 0.9990804 | 1.374193 | 1.1891694 | 1.4403617 | 1.3795796 | 1.5758718 | 1.6925857 | 1.7235629 | 1.5553431 | 1.5761071 | 1.4636716 | 1.4436505 | 1.4542183 | 1.4255944 | 1.2798472 | 0.9573005 | 0.1278172 | 0         | 0         | 0         | 0 | 23.514434 |
| 19.7 | 0.0004381 | 0.2409887 | 0.6150528 | 0.9990804 | 1.374193 | 1.1891694 | 1.4403617 | 1.3795796 | 1.5758718 | 1.6925857 | 1.7235629 | 1.5553431 | 1.5761071 | 1.4636716 | 1.4436505 | 1.4542183 | 1.4255944 | 1.2811283 | 1.0132716 | 0.1742101 | 0         | 0         | 0         | 0 | 23.618079 |
| 19.8 | 0.0004381 | 0.2409887 | 0.6150528 | 0.9990804 | 1.374193 | 1.1891694 | 1.4403617 | 1.3795796 | 1.5758718 | 1.6925857 | 1.7235629 | 1.5553431 | 1.5761071 | 1.4636716 | 1.4436505 | 1.4542183 | 1.4255944 | 1.2811283 | 1.0692428 | 0.2272306 | 0         | 0         | 0         | 0 | 23.727071 |
| 19.9 | 0.0004381 | 0.2409887 | 0.6150528 | 0.9990804 | 1.374193 | 1.1891694 | 1.4403617 | 1.3795796 | 1.5758718 | 1.6925857 | 1.7235629 | 1.5553431 | 1.5761071 | 1.4636716 | 1.4436505 | 1.4542183 | 1.4255944 | 1.2811283 | 1.1136338 | 0.2911392 | 0         | 0         | 0         | 0 | 23.83537  |
| 20   | 0.0004381 | 0.2409887 | 0.6150528 | 0.9990804 | 1.374193 | 1.1891694 | 1.4403617 | 1.3795796 | 1.5758718 | 1.6925857 | 1.7235629 | 1.5553431 | 1.5761071 | 1.4636716 | 1.4436505 | 1.4542183 | 1.4255944 | 1.2811283 | 1.1580247 | 0.3550478 | 4.905E-16 | 0         | 0         | 0 | 23.94367  |
| 20.1 | 0.0004381 | 0.2409887 | 0.6150528 | 0.9990804 | 1.374193 | 1.1891694 | 1.4403617 | 1.3795796 | 1.5758718 | 1.6925857 | 1.7235629 | 1.5553431 | 1.5761071 | 1.4636716 | 1.4436505 | 1.4542183 | 1.4255944 | 1.2811283 | 1.1927655 | 0.4241638 | 0.0034516 | 0         | 0         | 0 | 24.050978 |
| 20.2 | 0.0004381 | 0.2409887 | 0.6150528 | 0.9990804 | 1.374193 | 1.1891694 | 1.4403617 | 1.3795796 | 1.5758718 | 1.6925857 | 1.7235629 | 1.5553431 | 1.5761071 | 1.4636716 | 1.4436505 | 1.4542183 | 1.4255944 | 1.2811283 | 1.2275062 | 0.4885458 | 0.0129435 | 0         | 0         | 0 | 24.159593 |
| 20.3 | 0.0004381 | 0.2409887 | 0.6150528 | 0.9990804 | 1.374193 | 1.1891694 | 1.4403617 | 1.3795796 | 1.5758718 | 1.6925857 | 1.7235629 | 1.5553431 | 1.5761071 | 1.4636716 | 1.4436505 | 1.4542183 | 1.4255944 | 1.2811283 | 1.2468066 | 0.5481939 | 0.0293387 | 0         | 0         | 0 | 24.254937 |
| 20.4 | 0.0004381 | 0.2409887 | 0.6150528 | 0.9990804 | 1.374193 | 1.1891694 | 1.4403617 | 1.3795796 | 1.5758718 | 1.6925857 | 1.7235629 | 1.5553431 | 1.5761071 | 1.4636716 | 1.4436505 | 1.4542183 | 1.4255944 | 1.2811283 | 1.266107  | 0.6050015 | 0.0517741 | 0         | 0         | 0 | 24.35348  |
| 20.5 | 0.0004381 | 0.2409887 | 0.6150528 | 0.9990804 | 1.374193 | 1.1891694 | 1.4403617 | 1.3795796 | 1.5758718 | 1.6925857 | 1.7235629 | 1.5553431 | 1.5761071 | 1.4636716 | 1.4436505 | 1.4542183 | 1.4255944 | 1.2811283 | 1.2757573 | 0.6570752 | 0.0811128 | 0         | 0         | 0 | 24.444543 |
| 20.6 | 0.0004381 | 0.2409887 | 0.6150528 | 0.9990804 | 1.374193 | 1.1891694 | 1.4403617 | 1.3795796 | 1.5758718 | 1.6925857 | 1.7235629 | 1.5553431 | 1.5761071 | 1.4636716 | 1.4436505 | 1.4542183 | 1.4255944 | 1.2811283 | 1.2854075 | 0.7044149 | 0.1164918 | 0         | 0         | 0 | 24.536912 |
| 20.7 | 0.0004381 | 0.2409887 | 0.6150528 | 0.9990804 | 1.374193 | 1.1891694 | 1.4403617 | 1.3795796 | 1.5758718 | 1.6925857 | 1.7235629 | 1.5553431 | 1.5761071 | 1.4636716 | 1.4436505 | 1.4542183 | 1.4255944 | 1.2811283 | 1.2866942 | 0.7456005 | 0.158774  | 0         | 0         | 0 | 24.621666 |
| 20.8 | 0.0004381 | 0.2409887 | 0.6150528 | 0.9990804 | 1.374193 | 1.1891694 | 1.4403617 | 1.3795796 | 1.5758718 | 1.6925857 | 1.7235629 | 1.5553431 | 1.5761071 | 1.4636716 | 1.4436505 | 1.4542183 | 1.4255944 | 1.2811283 | 1.2866942 | 0.786786  | 0.2070965 | 0         | 0         | 0 | 24.711174 |
| 20.9 | 0.0004381 | 0.2409887 | 0.6150528 | 0.9990804 | 1.374193 | 1.1891694 | 1.4403617 | 1.3795796 | 1.5758718 | 1.6925857 | 1.7235629 | 1.5553431 | 1.5761071 | 1.4636716 | 1.4436505 | 1.4542183 | 1.4255944 | 1.2811283 | 1.2866942 | 0.8194504 | 0.2653424 | 0         | 0         | 0 | 24.802084 |
| 21   | 0.0004381 | 0.2409887 | 0.6150528 | 0.9990804 | 1.374193 | 1.1891694 | 1.4403617 | 1.3795796 | 1.5758718 | 1.6925857 | 1.7235629 | 1.5553431 | 1.5761071 | 1.4636716 | 1.4436505 | 1.4542183 | 1.4255944 | 1.2811283 | 1.2866942 | 0.8521148 | 0.3235883 | 7.864E-16 | 0         | 0 | 24.892995 |
| 21.1 | 0.0004381 | 0.2409887 | 0.6150528 | 0.9990804 | 1.374193 | 1.1891694 | 1.4403617 | 1.3795796 | 1.5758718 | 1.6925857 | 1.7235629 | 1.5553431 | 1.5761071 | 1.4636716 | 1.4436505 | 1.4542183 | 1.4255944 | 1.2811283 | 1.2866942 | 0.8776783 | 0.3865802 | 0.0027669 | 0         | 0 | 24.984317 |
| 21.2 | 0.0004381 | 0.2409887 | 0.6150528 | 0.9990804 | 1.374193 | 1.1891694 | 1.4403617 | 1.3795796 | 1.5758718 | 1.6925857 | 1.7235629 | 1.5553431 | 1.5761071 | 1.4636716 | 1.4436505 | 1.4542183 | 1.4255944 | 1.2811283 | 1.2866942 | 0.9032417 | 0.4452576 | 0.0103759 | 0         | 0 | 25.076167 |
| 21.3 | 0.0004381 | 0.2409887 | 0.6150528 | 0.9990804 | 1.374193 | 1.1891694 | 1.4403617 | 1.3795796 | 1.5758718 | 1.6925857 | 1.7235629 | 1.5553431 | 1.5761071 | 1.4636716 | 1.4436505 | 1.4542183 | 1.4255944 | 1.2811283 | 1.2866942 | 0.9174436 | 0.4996204 | 0.0235187 | 0         | 0 | 25.157874 |
| 21.4 | 0.0004381 | 0.2409887 | 0.6150528 | 0.9990804 | 1.374193 | 1.1891694 | 1.4403617 | 1.3795796 | 1.5758718 | 1.6925857 | 1.7235629 | 1.5553431 | 1.5761071 | 1.4636716 | 1.4436505 | 1.4542183 | 1.4255944 | 1.2811283 | 1.2866942 | 0.9316455 | 0.5513945 | 0.0415035 | 0         | 0 | 25.241835 |
| 21.5 | 0.0004381 | 0.2409887 | 0.6150528 | 0.9990804 | 1.374193 | 1.1891694 | 1.4403617 | 1.3795796 | 1.5758718 | 1.6925857 | 1.7235629 | 1.5553431 | 1.5761071 | 1.4636716 | 1.4436505 | 1.4542183 | 1.4255944 | 1.2811283 | 1.2866942 | 0.9387465 | 0.5988542 | 0.0650222 | 0         | 0 | 25.319914 |
| 21.6 | 0.0004381 | 0.2409887 | 0.6150528 | 0.9990804 | 1.374193 | 1.1891694 | 1.4403617 | 1.3795796 | 1.5758718 | 1.6925857 | 1.7235629 | 1.5553431 | 1.5761071 | 1.4636716 | 1.4436505 | 1.4542183 | 1.4255944 | 1.2811283 | 1.2866942 | 0.9458474 | 0.6419993 | 0.0933829 | 0         | 0 | 25.398521 |
| 21.7 | 0.0004381 | 0.2409887 | 0.6150528 | 0.9990804 | 1.374193 | 1.1891694 | 1.4403617 | 1.3795796 | 1.5758718 | 1.6925857 | 1.7235629 | 1.5553431 | 1.5761071 | 1.4636716 | 1.4436505 | 1.4542183 | 1.4255944 | 1.2811283 | 1.2866942 | 0.9467942 | 0.6795355 | 0.1272774 | 0         | 0 | 25.470899 |
| 21.8 | 0.0004381 | 0.2409887 | 0.6150528 | 0.9990804 | 1.374193 | 1.1891694 | 1.4403617 | 1.3795796 | 1.5758718 | 1.6925857 | 1.7235629 | 1.5553431 | 1.5761071 | 1.4636716 | 1.4436505 | 1.4542183 | 1.4255944 | 1.2811283 | 1.2866942 | 0.9467942 | 0.7170718 | 0.166014  | 0         | 0 | 25.547172 |
| 21.9 | 0.0004381 | 0.2409887 | 0.6150528 | 0.9990804 | 1.374193 | 1.1891694 | 1.4403617 | 1.3795796 | 1.5758718 | 1.6925857 | 1.7235629 | 1.5553431 | 1.5761071 | 1.4636716 | 1.4436505 | 1.4542183 | 1.4255944 | 1.2811283 | 1.2866942 | 0.9467942 | 0.7468419 | 0.2127055 | 0         | 0 | 25.623633 |
| 22   | 0.0004381 | 0.2409887 | 0.6150528 | 0.9990804 | 1.374193 | 1.1891694 | 1.4403617 | 1.3795796 | 1.5758718 | 1.6925857 | 1.7235629 | 1.5553431 | 1.5761071 | 1.4636716 | 1.4436505 | 1.4542183 | 1.4255944 | 1.2811283 | 1.2866942 | 0.9467942 | 0.776612  | 0.2593969 | 7.383E-16 | 0 | 25.700095 |
| 22.1 | 0.0004381 | 0.2409887 | 0.6150528 | 0.9990804 | 1.374193 | 1.1891694 | 1.4403617 | 1.3795796 | 1.5758718 | 1.6925857 | 1.7235629 | 1.5553431 | 1.5761071 | 1.4636716 | 1.4436505 | 1.4542183 | 1.4255944 | 1.2811283 | 1.2866942 | 0.9467942 | 0.7999104 | 0.3098929 | 0.0017317 | 0 | 25.775621 |
| 22.2 | 0.0004381 | 0.2409887 | 0.6150528 | 0.9990804 | 1.374193 | 1.1891694 | 1.4403617 | 1.3795796 | 1.5758718 | 1.6925857 | 1.7235629 | 1.5553431 | 1.5761071 | 1.4636716 | 1.4436505 | 1.4542183 | 1.4255944 | 1.2811283 | 1.2866942 | 0.9467942 | 0.8232088 | 0.3569302 | 0.006494  | 0 | 25.850719 |
| 22.3 | 0.0004381 | 0.2409887 | 0.6150528 | 0.9990804 | 1.374193 | 1.1891694 | 1.4403617 | 1.3795796 | 1.5758718 | 1.6925857 | 1.7235629 | 1.5553431 | 1.5761071 | 1.4636716 | 1.4436505 | 1.4542183 | 1.4255944 | 1.2811283 | 1.2866942 | 0.9467942 | 0.8361523 | 0.4005088 | 0.0147197 | 0 | 25.915467 |
| 22.4 | 0.0004381 | 0.2409887 | 0.6150528 | 0.9990804 | 1.374193 | 1.1891694 | 1.4403617 | 1.3795796 | 1.5758718 | 1.6925857 | 1.7235629 | 1.5553431 | 1.5761071 | 1.4636716 | 1.4436505 | 1.4542183 | 1.4255944 | 1.2811283 | 1.2866942 | 0.9467942 | 0.8490958 | 0.4420123 | 0.0259759 | 0 | 25.98117  |
| 22.5 | 0.0004381 | 0.2409887 | 0.6150528 | 0.9990804 | 1.374193 | 1.1891694 | 1.4403617 |           |           |           |           |           |           |           |           |           |           |           |           |           |           |           |           |   |           |





